

# 43<sup>rd</sup> World JAMBOREE

the SCOUT On the Air / Sur les Ondes  
World Scout Jamboree On the Internet / Sur Internet

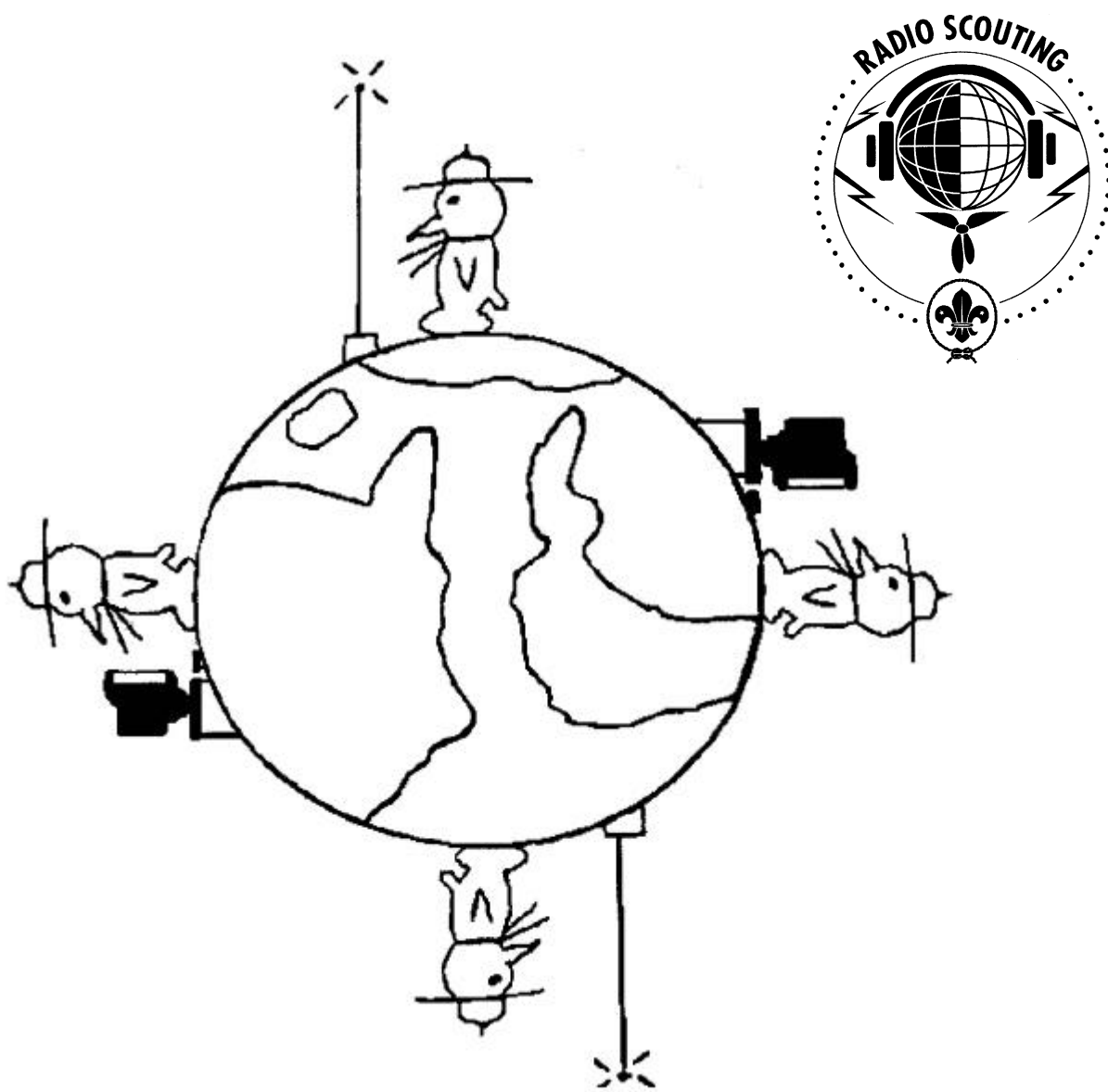

21 October **2000** 22 Octobre



World Organization  
of the Scout Movement  
Organisation Mondiale  
du Mouvement Scout

World JOTA Report  
Rapport Mondial du JSLO

# World JOTA Report

## the story of the world-wide

### 43<sup>rd</sup> Jamboree On The Air

21 - 22 October 2000



Each year in the third full weekend of October hundred-thousands of Scouts and Guides all over the world exchange greetings, learn about each others country and culture, swap programme ideas and make new friends. The contacts between them are established by amateur radio stations. This Jamboree-On-The-Air (JOTA) is the largest annual event for Scouts.

Chaque année durant le troisième week-end d'octobre, des centaines de milliers de Scouts et Guides dans le monde entier échangent des salutations, apprennent la culture des autres pays, se transmettent des idées de programme et se font des nouveaux amis, tout cela par contacts entre stations de radioamateurs. Ce Jamboree-Sur-Les-Ondes (JSLO) est la plus grande manifestation annuelle du Scoutisme. (Résumé français au chapitre 2).

Cada año, durante todo el tercer fin de semana de octubre, cientos de miles de scouts y guías de todo el mundo se envían saludos, aprenden acerca de otros países y culturas, comparten ideas para el programa y establecen nuevas amistades. Estos jóvenes toman contacto mediante estaciones de radioaficionados. El Jamboree en el aire (JOTA en inglés) es el acontecimiento scout anual más grande del mundo. (Resumen español en el capítulo 2).



# Contents:

1	From your editor	1
2	Résumé français / resumen español	2
3	The 43 <sup>rd</sup> JOTA in figures and graphs	3
4	The cartoon network game	8
5	JOTA in print	10
6	Reports from countries	13
7	Kit corner	36
8	Forthcoming radio-scouting events	38
9	The 44 <sup>th</sup> JOTA	39
10	National JOTA Organizers	41

©2001.

World Organization of the Scout Movement, Geneva, Switzerland. All rights reserved. Member Scout Organizations may reproduce portions of the text for non-commercial use, with credits for its source.

Published by the World Scout Bureau. Publication number 1310.

# 1. From your editor

Before you is the story of the 43rd Jamboree On The Air. In fact, it is not one story, but may be half a million stories. Each Scout will have his or her own recollection of the event: living the adventure, soldering an electronic gadget, making new friends. The JOTA, which is the largest annual WOSM event, enjoys a participation of some half-a-million Scouts each year. Some of these stories have been reported for you by the participants and you will find their adventures in this booklet.

New ideas reported in the JOTA stories:

- Scouts themselves introduce the Official that held the opening speech over the radio (Australia)
- An antenna designed by Scouts for the JOTA is named "*Scout roof*" (Germany)
- A reunion organised at the National station for former scouts and operators (Chile)
- A photo contest for the best JOTA picture (Denmark)
- Cooking the JOTA meals in a hay box (Namibia)
- A kit-building project to create awareness for landmine problems (Denmark)
- A whole town makes a community party out of the JOTA weekend (Chile)
- Radio stations organised in a "local-loop" net to circumvent the language difficulties (Tunisia)
- See your own voice go on the air, by hooking up an oscilloscope to the microphone (USA)

Like last year, the JOTA enjoyed the presence of a second WOSM event on the same weekend: the Jamboree On The Internet, or JOTI for short. From the reports it is apparent that most Scout groups used internet in combination with amateur radio stations. This has of course the main advantage that one can use the combination of the two events to its fullest to enhance the weekend programme for the Scouts. The use of internet saw a considerable growth compared to the previous years. It seems that JOTI is here to stay.

In most cases the national organisation teams take care of both events and we see more and more information material appear that combines these two popular ways of communicating with fellow Scouts world-wide.

One such combined activity was the Cartoon Network game. Scouts needed a radio station or Internet access to take part in this game. From the reports I noted that it was quite popular for those who did have a try, despite that not that many Associations gave any publicity to it. The target was to find 5 different JOTA drawings and to design two others yourself, in order to make a complete cartoon story out of it. In case you're still wondering how they all looked like, quickly go to chapter 4.

I would like to welcome the following new National JOTA Organisers (NJO's) who joined or rejoined us this year: Stephen Watson (Australia), Aminul Kawser (Bangladesh), Xochitl Prado Serrano (Mexico), Luis Hinojosa Pacheco (Peru), Magdi Osman Ahmed (Sudan), Mervijn O'Neil (Trinidad), Richard Gaskell (United Kingdom).

Possibilities of electronic communication have increased drastically. And we haven't seen the end of it yet. Your JOTA team has used the opportunity and made more JOTA information available on the web than ever before. Including this World JOTA Report, which has a full-colour, on-line version on our web site [www.scout.org/jota](http://www.scout.org/jota). A very large portion of all the reports we received from the National Scout Associations were emailed to us. This is certainly faster than sending it by traditional mail and a lot easier for your editor to handle. (The first report I wrote many years ago was done with a typewriter; each mistake meant retyping the page. Hard to imagine these days.)

Curious? Flip this page and have a taste of the international flavour of World Scouting. Happy reading!

Richard Middelkoop, PA3BAR  
Editor  
Sunday 28 January 2001

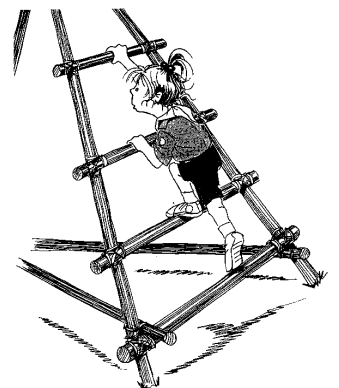

# 2. Résumé français / resumen español

Vous avez sous les yeux l'histoire du quarante-troisième Jamboree-Sur-Les-Ondes. En fait, il ne s'agit pas d'une seule histoire, mais de presque un demi-million d'histoires. Chaque scout(e) a de l'événement un souvenir qui lui est propre: pour certain(e)s ce sera l'aventure vécue, pour d'autres la réalisation de son propre instrument électronique, pour d'autres encore de s'être fait de nouveaux amis. Près d'un demi-million de scouts participent chaque année au JOTA, le plus grand événement annuel de l'OMMS. Certains épisodes du JOTA ont été relatés pour vous par les participants. Vous trouverez dans ce livret le récit de leurs aventures.

Nouvelles idées lues dans les petites histoires du JOTA:

- Des scouts qui présentent eux-mêmes à la radio la personnalité chargée de faire le discours d'ouverture (Australie)
- Une antenne conçue pour le JOTA par des scouts, dénommée le "toit scout" (Allemagne)
- Une réunion organisée à la station radio nationale pour d'anciens scouts et opérateurs (Chili)
- Un concours de photos pour la meilleure image du JOTA (Danemark)
- Des repas pour le JOTA cuits dans une caisse remplie de foin (Namibie)
- Un projet en kit pour susciter une prise de conscience sur le problème des mines antipersonnel (Danemark)
- Une ville entière qui fait du week-end du JOTA une fête communautaire (Chili)
- Des stations radio organisées en réseaux de "raccordement local" pour éviter les problèmes de langues (Tunisie)
- La visualisation de sa propre voix sur les ondes, en connectant un oscilloscope au microphone (Etats-Unis).

Comme l'année dernière, le JOTA a pu bénéficier de ce que le Jamboree sur Internet (JOTI) - autre événement annuel de l'OMMS - se soit déroulé le même week-end. Les rapports reçus font ressortir que la plupart des groupes scouts utilisent Internet en même temps que les stations radio amateur. Ceci a naturellement comme avantage principal d'utiliser la combinaison de deux événements pour mettre en valeur, de façon optimale, le programme du week-end pour les scouts. L'utilisation d'Internet connaît une croissance considérable par rapport aux années précédentes. Il semble que le JOTI se soit bien positionné pour durer. La plupart du temps les Organisations Scoutes Nationales disposent d'une équipe qui organise les deux événements à la fois et nous constatons que de plus en plus de matériel d'information est mis à disposition pour combiner ces deux modes de communication particulièrement populaires auprès des scouts qui peuvent se contacter dans le monde entier. L'une des activités communes était le jeu du dessin humoristique sur le réseau. Les scouts ont eu besoin d'une station radio ou d'un accès Internet pour y participer; d'après les rapports reçus, j'ai noté que le jeu avait plu à ceux qui l'avaient essayé, en dépit du fait que peu d'associations en avaient fait la publicité. Le but était de trouver sur le réseau 5 dessins différents du JOTA et d'en concevoir deux soi-même, afin de réaliser une bande dessinée. Si vous souhaitez savoir à quoi celle-ci ressemble, allez vite au chapitre 4.

Les possibilités de transmissions électroniques qui nous sont offertes à l'heure actuelle se sont considérablement accrues et ce n'est pas terminé. Votre équipe JOTA a saisi cette occasion pour mettre un grand nombre d'informations sur le web, beaucoup plus d'ailleurs que les années précédentes. Cela inclut ce rapport mondial du JOTA que vous trouverez en ligne sur notre site web: [www.scout.org/jota](http://www.scout.org/jota), en version polychrome. Une grande partie des rapports que nous avons reçus des Associations Scoutes Nationales a été envoyée par e-mail en format électronique. C'est certainement plus rapide que de les envoyer par la poste et beaucoup plus facile à manipuler par votre éditeur. (Le premier rapport que j'ai écrit, il y a pas mal d'années, a été tapé à la machine à écrire; cela signifiait qu'il fallait retaper la page à chaque fois qu'il y avait une erreur. Dur à imaginer de nos jours!).

Etes-vous curieux? Si oui tournez cette page, vous aurez un avant-goût du Scoutisme Mondial. Bonne lecture!

Presentamos aquí el relato del 43° Jamboree en el aire. De hecho no es UN relato sino que pudiera ser medio millón de historias. Cada scout conserva su propio recuerdo del evento: vivió su propia aventura, soldó su propio circuito electrónico, conoció nuevos amigos. El JEEA (JOTA), que es el acontecimiento scout anual más grande de la OMMS, cuenta con la participación de unos 500.000 scouts cada año. Algunas de estas historias han sido enviadas por los participantes para que usted conozca sus aventuras a través de este folleto.

Ideas nuevas tomadas de las historias del JOTA:

- Los propios scouts presentan a la autoridad que da el mensaje de apertura por radio (Australia).
- A una antena diseñada por los scouts para el JOTA se le puso el nombre "azotea scout" (Alemania).
- Reunión en la estación cabecera nacional de antiguos scouts y operadores de radio (Chile).
- Concurso fotográfico para la mejor imagen del JOTA (Dinamarca).
- Conservación ecológica del calor de las comidas del JOTA en cajas con paja (Namibia).
- Un proyecto para armar sobre el problema de las minas antipersonales (Dinamarca).
- Un pueblo entero hace una fiesta comunitaria con ocasión del fin de semana del JOTA (Chile).
- Estaciones de radio enlazadas en una red local para superar dificultades del lenguaje (Túnez).
- Se puede ver la propia voz ir al aire, con un osciloscopio conectado al micrófono (Estados Unidos).

Al igual que el año anterior, el JOTA compartió el fin de semana con un segundo acontecimiento de la OMMS: el Jamboree en Internet (JOTI en inglés). De los informes se desprende que la mayoría de los grupos scouts combinó el uso de Internet con estaciones de radioaficionados. Como es obvio, la ventaja principal de esta modalidad es que permite aprovechar al máximo la combinación de ambos eventos ampliando así el programa del fin de semana para los jóvenes scouts. El uso de Internet se vio incrementado considerablemente con respecto al año anterior. Parece que el JOTI llegó para quedarse.

En la mayor parte de los casos los equipos organizadores nacionales asumen estos dos eventos en conjunto y se ve cada vez más material informativo que combina estas dos formas de comunicarse con hermanos scouts de todo el mundo.

Una actividad que combinó ambos modos de comunicación fue el juego de la Historieta en Red. Para participar, los scouts podían acceder desde una estación de radio o desde una conexión a Internet. Por los informes he visto que el juego fue bastante popular entre los que lo intentaron, a pesar de que no fueron muchas las asociaciones que le dieron algo de publicidad. El propósito era encontrar cinco dibujos del JOTA y diseñar otros dos por parte de uno mismo con el objeto de completar una historieta con ellos. Si aún se están preguntando cuál era el aspecto de los dibujos que había que buscar se los puede ver en el capítulo 4.

Ha habido un notable crecimiento de las posibilidades de comunicación electrónica. Y todavía parece que crecerán mucho más. El equipo JOTA aprovechó la oportunidad y desplegó en Internet la mayor cantidad de información hasta ahora vista sobre el Jamboree en el aire. Se incluye este informe del JOTA, que cuenta con una versión en línea, a todo color, en nuestro sitio electrónico [www.scout.org/jota](http://www.scout.org/jota). Gran cantidad de los informes que recibimos de las asociaciones scouts nacionales fueron enviados por correo electrónico. Verdaderamente esta forma es mucho más rápida que el correo tradicional y mucho más fácil de manejar para el editor (el primer informe que preparé sobre el JOTA hace ya muchos años lo hice en una máquina de escribir: ante cada error había que hacer toda la página de nuevo, aunque parezca difícil de imaginarlo en la actualidad).

¿Les parece curioso? Al mover con rapidez esta página se puede sentir una muestra del sabor internacional del Movimiento Scout Mundial. ¡Feliz lectura!

# 3. The 43<sup>rd</sup> JOTA in figures and graphs

The 43<sup>rd</sup> Jamboree-On-The-Air enjoyed an enthusiastic worldwide participation. Our thanks go especially to those National JOTA Organizers and International Commissioners who have sent us the information of the JOTA in their country.

In this chapter, we have included statistics of JOTI participation as well. Merely to give you an idea of the interest in the growing use of internet technology during the weekend.

Scout amateur radio stations operated from the following countries for the 43<sup>rd</sup> JOTA:

I	R		I	R		I	R		I	R		
2		Algeria		2	Fiji		2	Lithuania		7	Russia	
	1	Angola	* 0	24	<u>Finland</u>	3	14	Luxembourg		1	Senegal	
* 50	54	Argentina	5	14	France	1		Macedonia		3	Slovakia	
* 4	25	<u>Australia</u>	* 1	31	<u>Germany</u>		1	Madagascar		1	7	Slovenia
* 17	23	<u>Austria</u>	4	13	Greece	3	1	Malaysia	* 6	7	South Africa	
*	5	<u>Bangladesh</u>	1		Grenada	5	11	Malta	6	18	Spain	
4	15	Belgium	1	3	Guatemala	2		Mauritius	* 0	1	Sri Lanka	
	1	Belize	* 9	18	<u>Guyana</u>	* 1	7	Mexico		1	St. Lucia	
5	6	Bolivia		1	Haiti		1	Moldavia	*	5	Sudan	
	1	Botswana	1	1	Honduras		1	Mongolia	* 0	8	<u>Surinam</u>	
7	9	Brazil	* 1	2	Hong Kong		4	Morocco		1	Swaziland	
	4	Bulgaria		10	Hungary		1	Mozambique	7	16	Sweden	
* 10	12	<u>Canada</u>	* 1	28	<u>Iceland</u>	* 18	22	Namibia	* 4	36	<u>Switzerland</u>	
* 0	26	<u>Chile</u>	2	4	India	* 5	14	<u>Neth. Antilles</u>		1	Tanzania	
1	8	China Rep.	5	4	Indonesia	* 10	22	<u>Netherlands</u>		1	5	Thailand
4	4	Colombia	*	8	Ireland	* 8	6	<u>New Zealand</u>	* 17	4	<u>Trinidad &amp; Tobago</u>	
2	5	Costa Rica		5	Israel		1	Nicaragua	* 21	14	<u>Tunisia</u>	
* 56	27	<u>Croatia</u>	5	21	Italy		1	Nigeria	* 16	9	<u>Turkey</u>	
* 12	16	<u>Cyprus</u>	2	3	Jamaica	* 32	34	<u>Norway</u>		1	Uganda	
* 0	66	<u>Czech Rep.</u>	* 6	12	Japan		3	Oman		5	<Ukraine>	
* 17	31	<u>Denmark</u>		2	Jordan		2	Panama	* 23	40	<u>United Kingdom</u>	
1	2	Dominica		1	Kiribati		1	Paraguay	* 9	51	<u>United States</u>	
2	3	Dominican Rep.		2	Korea	* 26	10	<u>Peru</u>		1	4	Uruguay
3	4	Ecuador	1	5	Kuwait	2	5	Philippines	6	10	Venezuela	
	1	Egypt		3	Latvia	* 0	39	<u>Poland</u>	*	66	World Bureau HB2S	
2	1	El Salvador	2		Lebanon	* 16	49	<u>Portugal</u>		3	13	Yugoslavia
5		Estonia		1	Libya		3	4	3	1	Zimbabwe	
2		Faroer Isl.		3	Liechtenstein	* 0	23	<u>Romania</u>				

Figure 1. Countries from which scout stations operated during the 43rd JOTA.  
 The number of other countries that were contacted is shown in front of a country's name, where "I" indicates contacts via internet and "R" contacts via radio.  
 \* indicates that a National JOTA Report is received and is quoted in chapter 6.  
underlined indicates that non-licenced scouts are allowed to speak themselves.  
 <country> indicates that the \*emerging Scout Organization is not \* a recognized WOSM member.

Figures, numbers and statistics. To convince your supporters that the JOTA is the largest annual WOSM activity, the next three pages have all the numbers you may need. Figure 2 shows the number of participating Scouts and Guides per country as a percentage of the total membership of Scouts and Guides (WOSM) and Guides (WAGGGS). For simplicity, beavers, cub-scouts, scouts, rovers and explorers have all been regarded as "Scouts" and similarly for the girls.

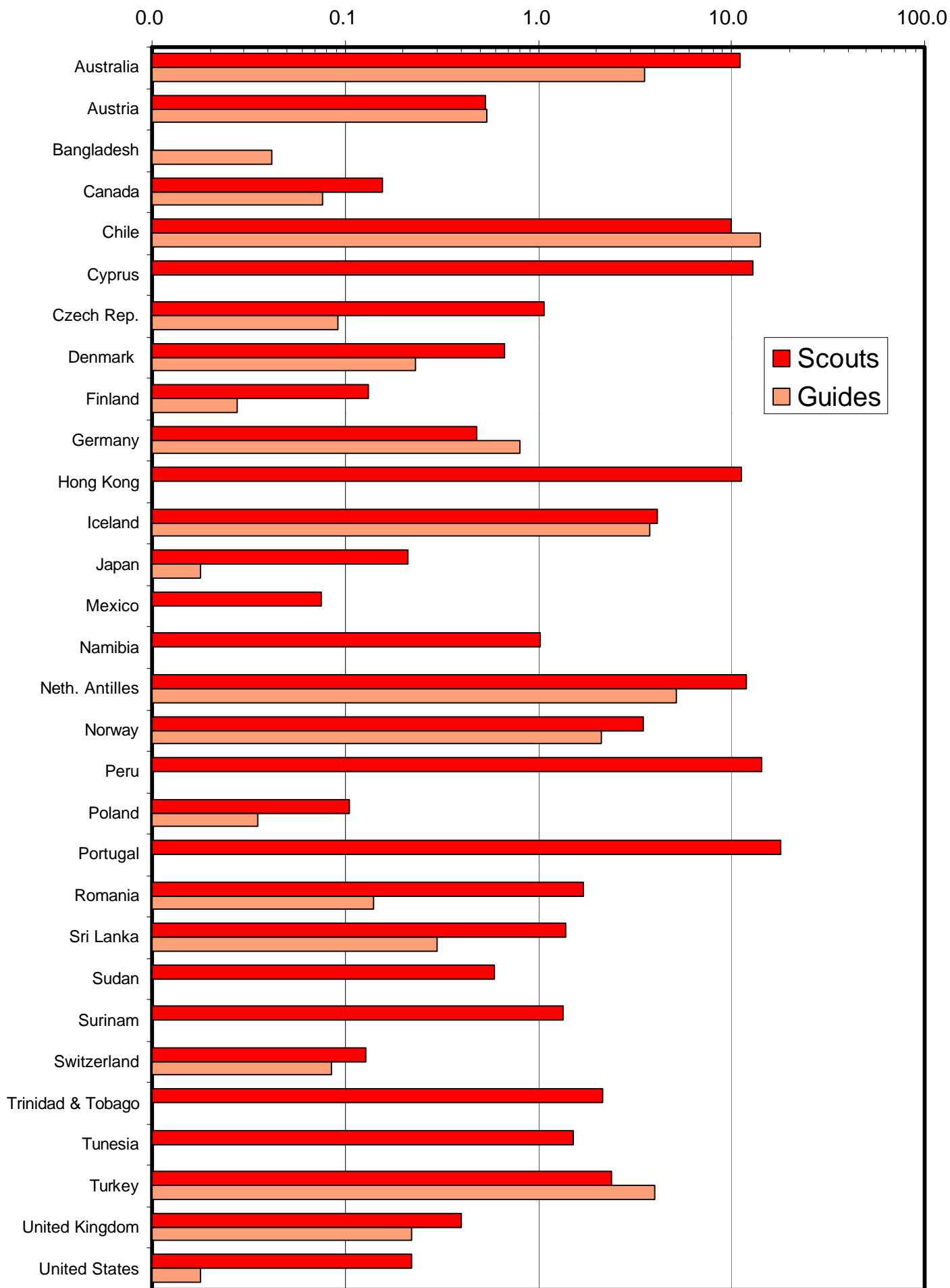

Figure 2. Percentage (%) of Scouts and Guides per country taking part in the JOTA.  
(Note: logarithmic scale !)



Using a relative number makes it easier to compare the participation in different countries. Please note that we have used a logarithmic scale in this graph. That means that both small and large numbers can be displayed in the same picture, but that the axis is not linear.

JOTA is not a competition and these figures merely indicate that there are differences in interest, organization and reporting in these countries. Local circumstances vary quite a bit.

		<b>JOTA</b>	<b>JOTI</b>
Scouts	:	401794	37848
Guides	:	59054	8308
<b>total participants</b>	:	<b>460848</b>	<b>46156</b>
JOTA radio stations	:	10707	
radio amateurs	:	8074	
internet locations	:		1462
visitors	:	55381	5512
active countries	:	108	67

Figure 3: Total participation in the 43<sup>rd</sup> Jamboree-On-The-Air and Jamboree On The Internet.

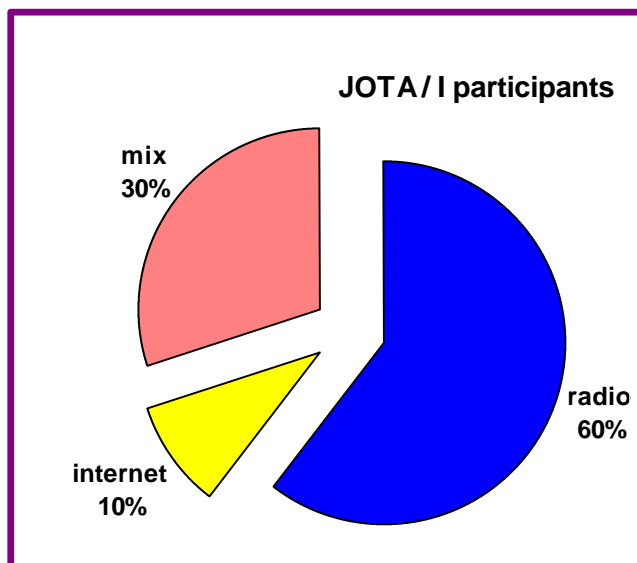

Figure 4. Division of JOTA / I participants.

To arrive at a reliable estimate of the total number of participants, some statistics are needed, since not all the countries have sent a JOTA report. These statistics are based on the average participation of the countries that did send a report (figure 2), on the membership number of each Scout or Guide Association and on the list of countries that were reported as being active in the event (figure 1). All this leads to the participation numbers presented in figure 3:

At a considerable number of stations, the use of internet was combined with the running of an amateur radio station. Compared to the 10707 radio stations, there were 1462 internet-only stations: scout groups that took part in the JOTI event without using amateur radio. This is quite an increase over last year when 808 internet-only stations were active. Many more internet stations were active, all combined with amateur radio stations and this category is the one that grows the fastest. Figure 4 shows the activity of the participants: those that took part with amateur radio only, those with internet only and those Scouts that operated a mixed station. The "radio-only" stations still have the large majority, but decreased compared to last year from 71 % to 60 %. The largest growth is in the mixed mode, from 22 % to 30 % this year, whilst internet-only grew from 7 % to 10 %.

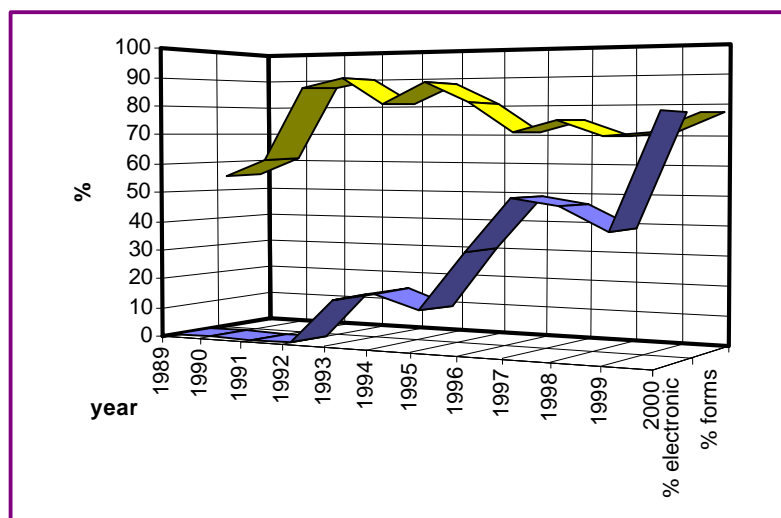

Figure 5. Reports sent electronically (% electronic), and reports containing a report form (% forms).

The number of national JOTA organizers that sent their reports on a computer disk, via packet-radio or via email increased dramatically this year to a mere 78 % ! Have a look at those numbers in figure 5. It's amazing. It is a very fast way of doing it. This allows electronic processing and saves a lot of time. It has certainly helped that we have made an electronic form available that could be downloaded from the web and sent via email. This was widely used by many NJO's. Figure 6 shows the number of times our JOTA web site was accessed; the JOTA weekend is not difficult to spot in this graph. !

A report form was used by 78 % of all the reports we received. It is a great help to receive your JOTA information in this standard way.

The only drawback may be that countries that are traditionally sending their report on paper, way after the deadline, now have a higher risk to "miss the boat", as we finalize the editing sooner than before.

We are improving the electronic processing of illustrations, photographs and newspaper articles. In fact, before you is the first fully electronic version of the JOTA report. Having it in this format means we can make it available on the Bureau's web site right after finishing the last page; long before you will receive the printed copy. This adds a lot to the actuality and fulfills the wish of many NJO's to have the worldwide JOTA overview available sooner after the event. And without bringing the reporting deadline forward! A big thanks to those NJO's who sent us their JOTA reports and to those who didn't, we hope to see yours next year.

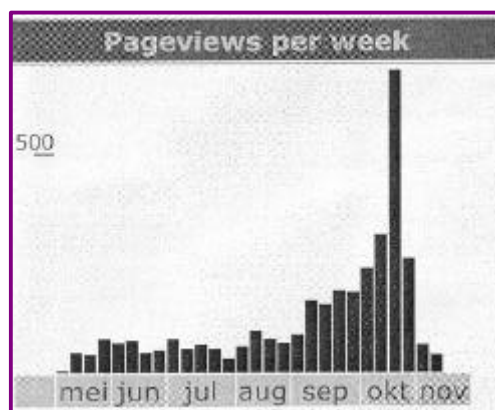

Figure 6. Number of accesses to the JOTA web page.

Figure 7 presents you the overview of the JOTA development over the years. For the last few years we have included the numbers of Scouts taking part in the JOTI and in mixed JOTA / JOTI stations.

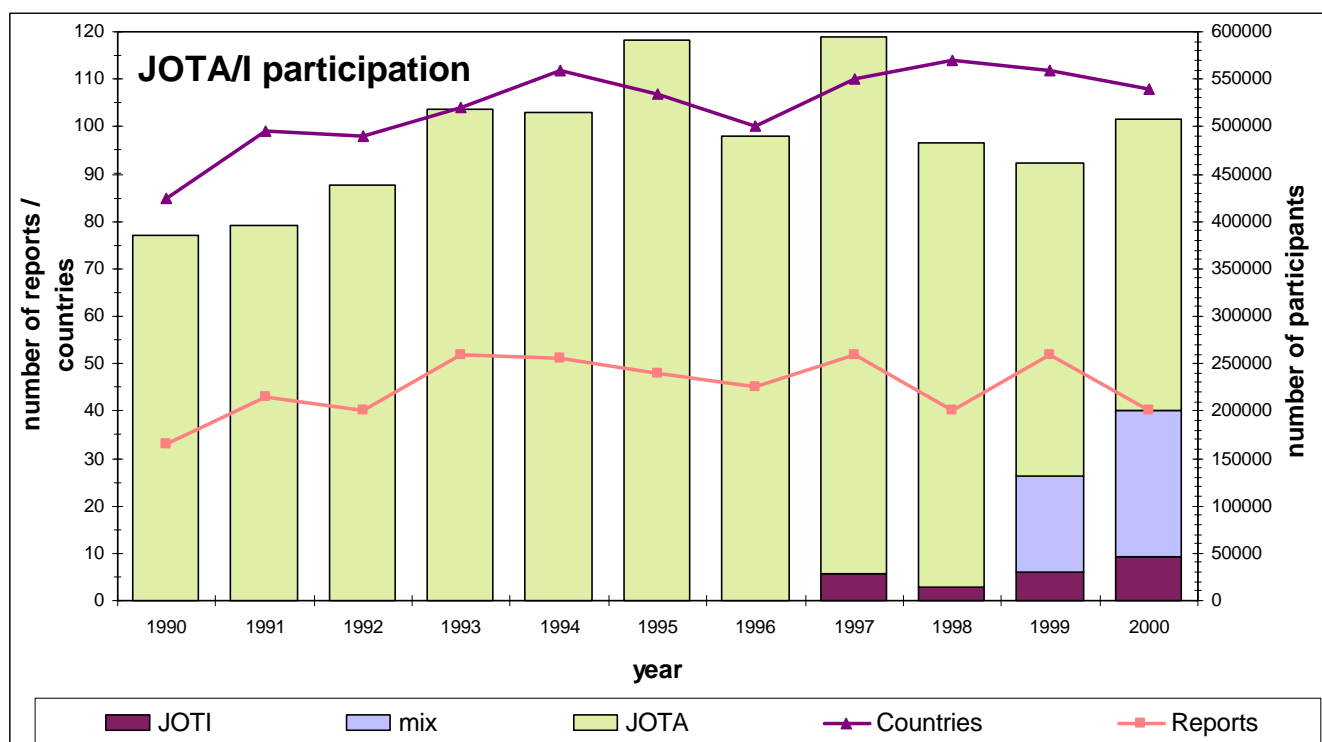

Figure 7: JOTA participation over the last decade.

The number of participants is shown as a column, related to the axis on the right hand side. The two lines show the number of countries involved and the number of National JOTA reports received by the World Scout Bureau. These lines correspond to the axis on the left-hand side.

**A complete overview of 35 years JOTA history has been compiled by Len Jarrett, the former World JOTA Organizer: "The JOTA story, 35 years of Scouting's Worldwide Jamboree-on-the-Air".** (This edition can now be ordered on line from [www.worldscoutshop.org](http://www.worldscoutshop.org)). From Len's book, we read the following:

**40 years ago: the 3rd JOTA, 22 - 23 October 1960.**

During the third JOTA, held on 22-23 October, 1960, the local radio club, prodded by Ray Thornton and Alf Sheffield, became involved as did the Army Signal Corps. The call sign VE3JAM was again used and the Army

gave permission to use Connaught Ranges, a camp just outside Ottawa, where the Signal Corps erected antennas 'as an exercise'. The equipment was superb - I believe we had three transmitters operating simultaneously, each running the maximum legal output. Results fully justified this lavish organization. Canadian Scouts had carried out massive publicity and, as a result, nearly 400 Canadian stations took part. I think VE3JAM spoke to almost every one. Certainly we were on the go for the full 48 hours and, according to the November issue of 'World Scouting', VE3JAM made over 400 contacts in 23 countries.

Other countries reported increased participation too, and so, for the first time, the Bureau issued a report, albeit a very slim one by present standards. Comments received were summarized and grouped by continent - separate reports by country did not start for another two years.

In Britain, the "Short Wave Magazine" reported on the event and mentioned that Scout David Sochachewsky of London had just received his license, having been introduced to amateur radio at the first JOTA in May, 1958. Since then many others have become involved in amateur radio as a result of JOTA.

At about this time, some National Scout Associations started to install permanent amateur radio stations. The January, 1961, issue of 'World Scouting' reports DU1BPS in the Philippines and YV5ARS in Venezuela, while remarking that K2BFW in the USA and XE1EW in Mexico had been operating for some time. It would not be long before the Bureau itself and other National Associations followed suit.

For me, the third JOTA was memorable, because it was then that I decided to get my own license, for I felt a little left out of things listening to the 'ham talk' during the weekend, and decided that "if you can't beat them - join them". So, in November, 1960,

I constructed a Heathkit AR3 receiver, stuck up an antenna on my apartment roof and started to listen to W1AW's practice C.W. sessions and to study technical manuals. The next year, I became the proud owner of the call VE3EWE (perfect for C.W.) and immediately ordered and constructed a Heathkit DX60 transmitter. But when I started to transmit, all my neighbours objected, for not knowing any better, I had laid my antenna on the roof (it had to be kept out of sight) across the master TV feeder. Operation had to be restricted to non-TV hours until I solved the whole problem by moving to a house with a garden.



Jamboree-on-the-Air, October 1960

### ***25 years ago: the 18th JOTA, 18 - 19 October 1975.***

A milestone for Radio-Scouting as a result of the magnificent exhibit at the World Jamboree in Norway. Three thousand five hundred electronic kits constructed; sixteenhundred Scouts experienced fox hunting using Scout-constructed receivers. First World JOTA Conference held.

Netherlands gets permission for Scouts to speak, starting a Radio-Scouting boom in that country.

### ***10 years ago: the 33rd JOTA, 20 - 21 October 1990.***

The newly recognized Scout organizations in Hungary and Czechoslovakia went on the air. The Scout station FF1SDF at the World Scout Conference in Paris in July had provoked their interest. For the first time Scouts from Turkey took part also with TA1KA from Istanbul. The national TV news covered the event and their report even included a videotape.

The German JOTA organizer wanted to transmit a puzzle game, but was puzzled himself when his equipment transmitted smoke signals instead.

In Jamaica the national station was swamped with Cub Scouts suddenly and the JOTA organizer found himself "nursemaiding" part of the time. From Kenya Scouting songs in Swahili went on the air transmitted by 5Z4KSA in Paxtu, Nyeri. A Scout station in the Netherlands contacted Scouts in England operating from a factory where stockings were made for the Royal family; a quick deal was made: swap a few Dutch stockings for Royal ones. Scouts in Zimbabwe operated Z27JAM and almost blew their radio tubes trying to contact HB9S at the World Bureau in Geneva: they got through. In Portugal the Scouts received permission to speak directly over the radio. Their press release reads: "of JOTA we can say that the World is embraced by youngsters proclaiming a world of peace, brotherhood and understanding".

# 4. The cartoon network game

What is it all about? Well, a game for which you needed the internet as well as the packet-radio network. Not necessarily both, as you could ask the help of other Scout groups.

The aim of the game was to collect a series of JOTA cartoons that are spread out over the world-wide communications network, complete the pictures and write your own JOTA story. In total there are 7 cartoons.

What did you have to do?

- Find on the Internet 3 cartoons that are part of this game, which have been hidden on the www sites of several national Scout organizations around the world. The cartoons each have a number, so you can identify them. You can start by visiting the "national links" section of the World Organization of the Scout Movement at [www.scout.org](http://www.scout.org), and pick a country that interests you. To see if they have the cartoon, add "/cartoon" at the end of the URL. For example: [www.scout.org/cartoon](http://www.scout.org/cartoon). If it is there, the cartoon can be downloaded.
- Find another 2 cartoons that are placed in packet-radio mailboxes, in the directory JOTA@WW. These pictures are in 7-plus format, well known to radio amateurs.
- In each picture, write (or add with your computer) the text you feel is most appropriate in the balloons.
- Draw 2 additional cartoons yourself. In this way you complete your own JOTA story.
- Send the 7 pictures that form your own JOTA cartoon to the World Scout Bureau.

And here they are:

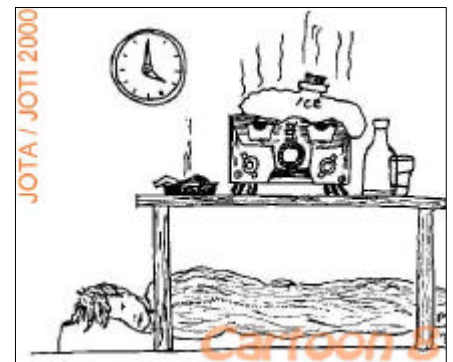
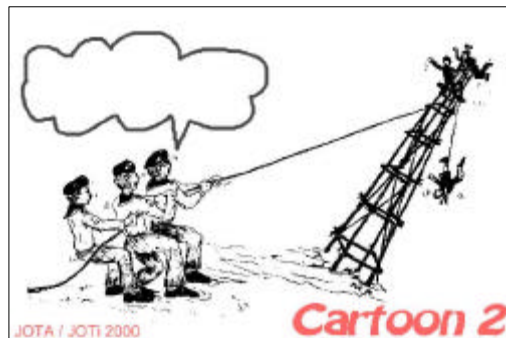
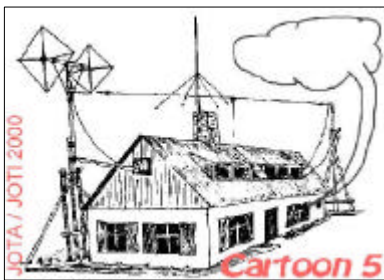

Yes, there's one too many. That's the number 8. We have put this "joker" cartoon as an extra on the JOTA web pages, reachable via the World Scout Bureau web server.

Where were they?

Cartoon 1: Argentina (1065 downloads) and Luxembourg (102 downloads);

Cartoon 2: Denmark (175 downloads), South Africa and United Kingdom;

Cartoon 3: on the packet-radio network;

Cartoon 4: on the packet-radio network;

Cartoon 5: China (244 downloads) and Netherlands (64 downloads);

Cartoon 8: Geneva (128 downloads).





From the received JOTA reports we noted that very little publicity was given to this game, despite our early announcement of it in the JOTA circular in May. This is a bit puzzling as several National JOTA Organizers in the same reports ask for games involving both radio and internet. Moreover, the European NJO's and promoted this sort of game early May in Rome.

Looking at the statistics from the web sites, however, quite a few Scouts had fun with it. The first entry we received in Geneva came by telefax on the Sunday morning from the JOTI station Holmen in Copenhagen; it's the one you see on this page.

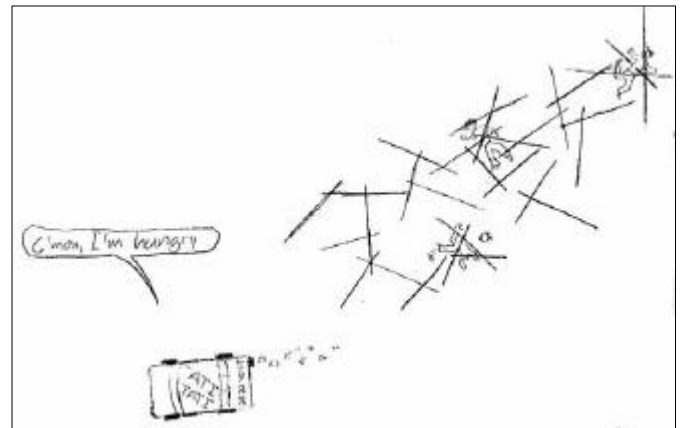
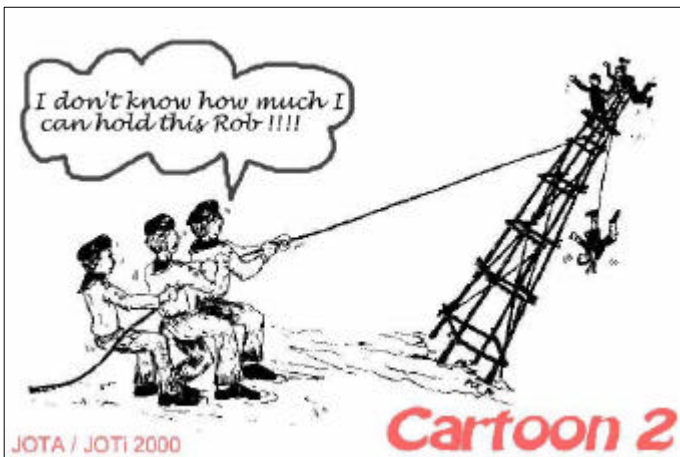

Thanks to the webmasters of the National Scout Association in Denmark, United Kingdom, Netherlands, Argentina, China, South Africa and Luxembourg for their assistance with this game. They made sure that the cartoons were on line for the JOTA / JOTI weekend.



# Sur les ondes et Internet Jamborée Scout Mondial

Les Scouts tunisiens participent pour la quatrième année consécutive au 43ème Jamborée Mondial sur les ondes "jota (les radios amateurs) et le quatrième Jamborée Mondial sur Internet "joti".

Ces deux événements internationaux sont organisés par l'Organisation Mondiale du Scoutisme chaque année à cette date.

A cet effet, un rassemblement sera organisé du 20 au 22 octobre courant au Centre international de camping et de formation à Borj Cédria où prendront part des jeunes scouts garçons et filles de toutes les régions de la Tunisie. Les 3 stations des radios amateurs seront à leur disposition et répondront aux appels suivants: 3V8ST au siège national des scouts tunisiens, 3V8CB au Centre de Borj Cédria et 3V8BB à l'Institut Supérieur de Bir El Bey, d'autre part une liaison internationale via Internet permettra aux jeunes de communiquer avec des jeunes scouts du monde entier.

Cet événement sera ouvert officiellement par le Commissaire général des scouts tunisiens M. Mohamed Triki en compagnie des responsables locaux de Hammam Chatt et du président de l'Association tunisienne des radios amateurs (ASTRA) le samedi 21 octobre 2000 à 16H au Centre scout international de camping et de formation de Borj Cedria.

Il est à noter que le hobby des radios amateurs est très répandu dans le monde plus de 70 millions de stations sont reconnus dans le monde entier. D'autre part, un demi-million de jeunes scouts participeront chaque année au joti et au jota afin d'échanger leurs connaissances et de consolider les relations d'amitié et de fraternité.

## Scouting doet mee aan Jamboree on the air



■ JOTA zaterdag in Kaatsheuvel

KAATSHEUVEL – Tijdens het weekeinde van 21 en 22 oktober wordt voor de 43e keer de Jamboree On The Air (JOTA) gehouden. De JOTA is het grote jaarlijkse internationale zendevenement van Scouting. Over de hele wereld nemen zo'n half miljoen scouts aan dit evenement deel. In Nederland zijn er meer dan 250 scoutingstations actief, bevolkt door meer dan 20.000 scoutingleden.

Eén van de zendstations is gevestigd in clubgebouw Dde Bosvaert van Scouting Martin Luther King te Kaatsheuvel. Het hele weekend leggen ongeveer 200 leden van deze groep met behulp van zendapparatuur contacten over de hele wereld. Ze spreken met scouts uit Portugal, Spanje, Malta, Azoren, Verenig-

de Staten, Griekenland, Finland, Engeland, Duitsland, België en natuurlijk ook Nederland.

### Zevende keer

Scouting Martin Luther King neemt dit jaar voor de zevende keer deel aan de JOTA. De zendamateurs Marrie en Hans Rosenbrand werken belangeloos mee aan dit evenement.

Verder gaat de scoutinggroep dit jaar weer onder begeleiding van Wilbert Smits meedoen aan de JOTI (Jamboree on the Internet). Er is zelfs een eigen pagina, een zogenaamde home-page met onder andere foto's van de groep. Dit jaar is er ook een webcam aanwezig. Hiermee is het zendstation live te zien op internet. Op zaterdagochtend om

09.00 uur beginnen de uitzendingen en duren tot diep in de volgende dag. Alle belangstellenden zijn welkom op zaterdag 21 oktober van 09.00 tot 11.00 en van 13.30 tot 16.00 uur in clubgebouw De Bosvaert, Burg van Besouwlaan 2 in Kaatsheuvel.

### Drunen

Ook de Dr. Akkermans scoutinggroep uit Drunen neemt deel aan de Jamboree On the Air. Belangstellenden kunnen ook hier een kijkje nemen op vrijdag 20 oktober vanaf 23.00 uur tot zaterdagochtend 11.00 uur. En op zaterdagavond vanaf 21.00 uur tot zondag 14.00 uur in het clubgebouw De Akkerhoek ana de Duinweg 35 in Drunen.

ジャンボリー・オン・ジ・エア (JOTA)の目的は、電波を通して、国内各地や外国のまた会ったことのない兄弟スカウトたちと話をかわして、お互いを理解し、知識と友情を深めることです。無線通信やエレクトロニクスについて興味と夢を持ち、スカウティングの素晴らしさに出会うため、今年もJOTAに参加し、成功させましょう。

Double fun  
at Jamborees





### Pfadi-Kommunikation auf dem «TägeliBock»

In Zum 43. Mal fand am Wochenende das weltweit grösste «Pfadi-treffen» statt: «Jamboree on the Air». Ausgerüstet mit Funk- und Morsegeräten sowie mit Computern versuchten weltweit rund 500.000 Pfadis, zwischen 14 Uhr am Samstag und 14 Uhr am Sonntag miteinander in Kontakt zu treten. Die Schweiz war mit über 300 Pfadis vertreten, 20 davon waren auf dem «TägeliBock» im Sendli bei Bözigen eingquartiert. Die Herausforderung bestand darin, mit einfachen Mitteln und auf engsten Platzverhältnissen möglichst viele weit entfernte Stationen zu erreichen. Die Pfadis demonstrieren den Besuchern verschiedene Akti-

viäten wie Funken – wobei erstmals und nur an diesem Wochenende auch nicht lizenzierte Pfadis am Mikrofon durften –, Packet Radio (computerunterstütztes Funken), Fuchsjagd (mittels Peilen Sender suchen) oder Zusammenbauen elektronischer Bausteine. Am Sonntag um 9 Uhr wurde ein schweizerischer Rundspruch veranstaltet, wobei sich die 15 Stationen gegenseitig über ihre Aktivitäten und bisherigen Kontakte am Jamboree informierten. – Bild: Das Herzstück des 43. «Jamboree on the Air»: die Funkstation, die aussergewöhnlich auch von nicht lizenzierten Pfadis benutzt werden durfte.

(Foto: Liliane Rüfenacht)

# Primarul, eterul și cercetașii

Primarul Radu Hanga a fost primul care a lansat în eter, vineri noaptea, la ora 1, un mesaj pentru startul acțiunii YOTA - mesaje prin rețeaua radioamatorilor - a cercetașilor



(scout) din Câmpia Turzii! Acțiunea, a 43-a la nivel mondial, a cuprins cercetași de pe întreg mapamondul. Clubul local a fost la înălțime, atât prin numărul membrilor, cât și prin numărul și calitatea legăturilor realizate cu cluburi similare din Europa și chiar de pe alte continente.

Clubul din Câmpia Turzii s-a constituit în 1998, este integrat în mișcarea românească a cercetașilor și își desfășoară activitatea în spiritul principiilor stabilite în 1910 de inițiatorul acestei mișcări, Lord Robert Baden Powell of Gilwell. Cei 75 de membri sunt coordonați de un pensionar olandez, cercetaș cu vechi state de serviciu, pentru a fi gata oricând în folosul comunității. Clubul lucrează permanent cu primăria; armata, poliția, spitalul, școlile și, mai ales, cu părinții cercetașilor.

Zamfir Pop



World came to Gourock

## QRV aus dem Pfadilager



Ende Juli/Anfang August trafen sich mehr als 800 bayerische Pfadfinder des Verbands Christlicher Pfadfinder (VCP) auf einem Zeltplatz bei Breitenbrunn im Altmühltal. Die jüngsten Teilnehmer waren 11 Jahre alt, die Ältesten 25.

Lars, DC7RL, und ich, DL5RMH (beide 17 Jahre), sind selbst Pfadfinder, hatten die Idee, uns dort als Funkamateure vorzustellen. Wir bekamen eine Zusage, im Lager einen Baucontainer als Shack und einen Platz für den Antennenaufbau, und das Clubrufzeichen DL0LA und Sonder-DOK 2000LALA.

Also rückten wir einen Tag vor Beginn mit 12-m-Fieldday-Kurbelmast, 3-Ele.-Beam für die Highbands, einer 2-fach umschaltbaren Array für 40 m und einer Drahtantenne für 80 m/160 m auf dem Zeltplatz an. Zusätzlich hatten wir noch drei PCs, zwei UKW-Handfunkgeräte, einen Kurzwellentransceiver (IC-737) und eine Selbstbau-Transistor-Endstufe nach DL9AH mit.

Wir waren ein eigener Programmpunkt! Das hieß für uns, dass wir zweimal täglich jeweils ca. 7...10 Jugendliche um 9 Uhr und 15 Uhr bei uns im Container begrüßen durften, und das an mehr als sechs Programmtagen!

So ging es auch dann am zweiten Lager-tag los, und niemand von uns wusste zunächst so recht, wie wir der ersten

Gruppe unser Hobby verständlich machen sollen. Außerdem kam noch dazu, dass es sich dabei um junge Italienerinnen handelte, die fast kein Wort Englisch beherrschten! Dies ließ sich auch durch die „Dolmetscherin“ nicht in den Griff kriegen, da auch sie nur etwas Schulitalienisch beherrschte – am Ende hatten wir trotz allem das Problem, alle wieder aus unserem Container zu bekommen!



Amateurfunkvorführungen für bayerische Pfadfinder bei Breitenbrunn im Altmühltal

Wir zeigten ihnen den World Wide Convers, bei dem sie sich mit Funkern aus aller Welt unterhalten haben. Die restlichen Gäste waren Pfadfinder-Gruppen aus Bayern, die wir auch mit Amateurfunk begeistern konnten.



# 6. Reports from countries

Note:

Indicated per country you will find the numbers of participants, of JOTA radio stations, of internet-only stations **not** using amateur radio and the number of different countries that were contacted. A question mark "?" indicates that the numbers were not given in the report.

## Argentina (LU)

participants:	224
stations:	?
internet:	?
countries:	50

We did not have a National JOTA/JOTI Organizer but we encouraged the Groups to take part in these events and many of them did so, writes International Commissioner Ana Elisa Piubello.

## Australia (VK)

participants:	15350
stations:	300
internet:	150
countries:	25

Newly appointed National JOTA Organizer Stephen Watson writes in the preface to his report: the special callsign prefix AX, authorized by the Australian Communications Authority to celebrate Sydney 2000 and the Paralympics, was widely used by Scout and Guide stations. A mix of technology was present in JOTA stations with slow scan TV, packet, HF, and VHF being the most popular modes. There is a rapidly growing level of comfort with, and knowledge of, the internet among Youth Members and Leaders, and the JOTI activities Internet Relay Chat, email, and web surfing were very popular. A limitation in many cases was the cost associated with the activity. While some groups were able to obtain local sponsorship this was often limited and the time all too soon ran out.

The National Address this year was a great success. Many reported that it was the first time that it had been heard at their station. Many Scout and Amateur stations and repeaters throughout Australia broadcast the National JOTA/JOTI Address at 0300Z (1400EST) on Saturday the 21st of October. Twelve tapes were sent out, to each division of the Wireless Institute of Australia and to the Scout and Guide broadcast stations. Other stations downloaded the audio from the web site.

To change the feel of the Address, to involve youth, and increase the appeal to youth members I changed the tradition, which used to have the National Co-ordinator introduce the speakers. This year Scout Brooke Corrick from Camira Scout Group in Brisbane filled that role admirably, and her efforts were very well received by all.

Dr Bruce Munro, the chief Scout commissioner of Australia, mentioned in his opening address: *I find it exciting to be opening an activity that involves so many Scouts and Guides in Australia and all over the World. Many exchanges between young people provide them with an understanding of the rich cultural diversity of people throughout the World, and continually strengthen Scouting's major contribution to World peace in this, the 'International Year of the Culture of Peace and Thanksgiving'. I would hope that some of you are able to make radio contact with our fellow Scouts in East Timor. They've suffered enormously over the past twelve*



"G'day mate, listen to Pete here with an Aussie joke...."

months and it is pleasing for me to tell you that Scouting has restarted in East Timor with the support of the United Nations, Portugal, and Australia.

Mrs Mandy Macky, the chief Guide commissioner, added: *we recently sent a young Leader to a meeting in the United Nations in New York, and she was most impressed to find that Guiding is represented at the United Nations. I hope that you'll have a great time talking to other Guides and Scouts in different places around the World. Just making those first connections may give you the opportunity to make new friends in other places.*

## **'Try these JOTA/JOTI activities'**

### **Beaver Scouts**

- Telephones: Use tins or plastic cups, fasten a fine string between them and keep it tight while speaking, or talk through long pipes.

### **Cub Scouts**

- Junk: Get some scrap computers, VCRs, and radios etc, provide tools like screw drivers, wire cutters, and spanners, and stand back. Warning - Leave no good equipment near the junk or it may get dismantled. (*Safety first* - Ensure someone with electrical knowledge inspects the junk to discharge capacitors, remove power leads and batteries etc.)
- Signals: Make Semaphore flags by tacking cloth squares onto dowel, or use mirrors and see if you can communicate.

### **Scouts**

- Electronic kits: Building small kits is well worth the effort. I have diagrams and instructions for simple, inexpensive DIY kits for Crystal Radio, Morse code, and Blinking lights, which I will send you on request.
- QSL cards: Amateur Operators exchange cards detailing their radio contact, with a brief greeting. Print cards before JOTA or have youth members make their own. Send one card to each station your Group contacts, or Youth members could send one to the person they spoke with. A card is best filled out during the contact.
- Antenna tower: Build an antenna tower with poles and rope, including halyards for hoisting wire antennas. A good project for Adventurer level construction and a great on-air conversation topic. Ask your operator for advice.

### **Venturers / Rovers**

- Packet Radio: Messages are sent from one computer to another via a network of Amateur radio stations and repeaters. Chat to other stations 'live', or send messages Worldwide. Ask your operator.
- Nightlife: Interesting JOTA contacts can be made during the night as the some Frequency bands open to Worldwide stations. Keeping your radio operator up past midnight may require bribery. World time zones are important as half the World is always in darkness. JOTI contacts at night will help you to meet *Scouts* on the other side of the World.

### **Leaders**

- World map: Fasten maps of the World and Australia on a board, locate each Group you contact with a coloured pin, and you will be able to show all the places that were contacted. Use purple for Scouts, blue for Guides, and yellow for others. Coloured toothpicks and blue tack are an alternative. World atlas computer programs are also good.
- Cheat sheets: Avoid microphone/keyboard shyness and brief transmissions by having each youth member write a story about him/herself, or by filling in blanks on a sheet which you have prepared. Introduce youth members to the other station and have them read or type it. They must concentrate, take notes, and respond to what was said.

The Branch HQ base in **Queensland** was located at BP Park Samford with a number of Joeys, Cubs, Scouts and Venturers from Brisbane and Gold Coast Groups participating in the weekend, writes Stephen Watson.

JOTA 2000 went very well in the north of the State with Guide and Scout groups participating in ARDF, Slow Scan TV, Packet Radio (which a lot of them called 'the internet'), disassembly of electronic apparatus, and local, interstate and international voice contacts. Two groups also deployed 70MHz hand held radios to maintain on-demand contact. Stations were set up in Guide and Scout halls, out in the bush at Guide and Scout Camps and portable situations under canvas.

Glennie Heights Scouts (Warwick) went to their local Internet Café to participate in JOTI for some of Saturday. Clermont Scout Group, participating in JOTI at a school, had a brush with the law when

neighbours thought their all night chat session was the work of vandals. Apart from the police they were also visited during the night by a friendly cat. Fraser district and Maryborough Amateur Radio Club hosted a massive JOTA with 222 participants. Bayview Scout Group was very impressed when they chatted with a UK Group who had a video camera set up and they could see the people they were talking to.

Kirwan Scout Group went into the bush for JOTA but that didn't limit their fun. Their high tech tent had such offerings as Slow Scan TV, walky talkies, packet radio, HF radio, and VHF radio courtesy of their operator



Gavin VK4ZZ. For the frustrated there was a wrecking table where youth members could destroy obsolete electronic equipment while learning about how things tick. A big water fight broke out before the closing ceremony.

All reports seem to be very positive with the main complaint being lack of knowledge of the internet, says Joy Savill in **Victoria**. Most who approached schools have found them to be of great help.

Many Guides also enjoyed the 'extras' many Radio Operators are able to offer. The Sydnal North Junior Guides were able to see slow scan TV from Frankston station VK3SAF from the Mildara Scout Hall which is the Radio Clubrooms of the local Radio Club. Others were able to send their messages by using packet radio.

JOTI was more successful this year as many more contacts were made. A few units found it difficult to get started by using Scoutlink once on the contacts continued to come.



Kyabram Guides find that JOTA/JOTI weekend falls on their show day but they found by starting late in the day they could fit both activities in. They had such good fun they can't wait until next year to 'talk' to the World again. The leader who has very basic computer knowledge was amazed at how even the smaller Guides were able to make use of this medium.

The Guides on King Island were also able to take part this year. These girls are Lone Guides so it gave them an extra thrill to be able to take part in an activity with all the rest of the World.

Peter Fraser collected these comments from participants:

I found a lack of enthusiasm amongst the youth members and limited support from Leaders due to other Scouting commitments on this weekend. This was raised at Group Council and a commitment was given to fully support the event next year.

Great time. Late night. Plenty happening.

We had a very quiet time at my house (CSL) due to a busier than usual schedule. We got a thrill from meeting a scout from Perth Saturday night that contacted us because a cub from his group who we had met Saturday morning had said we were fun to chat with. It was a really nice feeling to hear that.

Met up with a few people from last year which was great.

Of all the reports and feedback that was received about the Cartoon Network, only 8 "participated".

Peter Martin in **Western Australia** comments: April 2001 looks like a good time to start with the promotion of JOTA / JOTI in W.A. Our Training team starts with the new leaders in training and this will be a starting point to promote the biggest and best activity in Scouting JOTA / JOTI.



The number of JOTA stations active in **South Australia** was less than last year in total, notices Dean Whitehorn. The number of JOTI stations active in SA was higher than last year. Overall, participants were up around 10% on last year. Increased participation was due to a number of reasons including JOTA/JOTI stations at Jamboree Shakedown camps. There was a greater expectancy of overseas JOTA contacts due to publicity in promotional material. The Radio Activities Group was very active

and visible at many events, and achieved better communication to groups by radio via our website. Mixed JOTA/JOTI stations are working better as they have more to offer and there is better active participation by amateurs. Preparation by groups was improved by having lead up nights, and there was much better communications from National. Negative points were continued amateur operator frustration with JOTI, few stations working on Sunday outside SA.



Frank Turnham in the **Northern Territory** writes: the report from Nhulunbuy indicates that JOTI was the preferred activity at that site. The GL suggested that something could be done to enhance the JOTA activity, perhaps satellite QSOs. Conditions were poor during the early part of both days improving during the evening. The Darwin activity took place at Howard Springs with a weekend camp with the main

activities being based on communication. It was planned to operate a JOTI site from a high school nearby where 40 terminals were setup for the Scout IRCs. Unfortunately disaster struck when it was found that the NT government server had been programmed to exclude chat channels. So all in all a very disappointing JOTI activity. There were 2 terminals setup at the Howard Springs Scout Hall where we had the radio.

In **Tasmania** the North West Division held our annual camp at Myalla. 234 girls used the radio and internet and about 46 leaders took part. JOTI is becoming very interesting for the girls. The radio contacts are still a bit poor owing to weather conditions, but some interesting contacts were made, says Elayne Ransley.

Maralyn Johnson in **New South Wales** comments: JOTI – there were mixed reactions to the establishment of an official internet activity for the first time in 1997, however, today in the year 2000 I can definitely say that the positives comments certainly outweigh the negatives. In terms of numbers it is estimated that 100 JOTI sites around New South Wales were operating versus 15 radio bases with official Girl Guide callsigns. I cannot pay adequate tribute to the amateur radio operators/ computer technicians, parent support and our devoted leaders who gave the girls the best they could in an interesting, educational, exciting and safe environment. Radio, Computers and electronics is an interesting and challenging field and we need to sell and promote the product to every unit leader to include JOTA/JOTI in their event calendar for 2001.

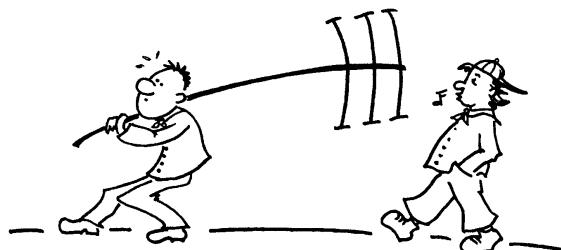

### Austria (OE)

participants:	147
stations:	8
internet:	0
countries:	23

The 43<sup>rd</sup> JOTA was again blessed with wonderful weather, says Walter Nowakowski, which enabled us to carry out supporting programs outside.

As usual, OE3DBU operated from the Devilstone cabin at 602 m high. A campfire added to the weekend. OE1XSC was run by Ernst, but unfortunately none of the Scouts of the Leibnitz troop showed up, so Ernst explored the wonderful world of internet. On the contrary, OE1WN seemed to have all the JOTA Scouts in Austria with him at the station, as he was swamped with a mere 100. The morse code generator proved to be a popular activity. The kitbuilding subject was a moon-compass, a design from an old English Scout magazine. Another fun play was a foxhunt during which the Scouts were blindfolded.

Other stations included OE1XPB in Höflein an der Donau, OE3FJL with the guide group Traunsee, OE2P and OE3J both unfortunately without Scouts present. Despite our attempts no one had a contact with HB2S.

### Bangladesh (S2)

participants:	95
stations:	1
internet:	0
countries:	5

For the last five years Bangladesh scouts arranged demonstrations of amateur radio station in its different national camps with the help of other amateur stations but this time Bangladesh Scouts participated in the World Jamboree On The Air with their own club station. A very good start, says Aminul Kawser in his report.

Bangladesh Scouts organized a national camp from 20th - 23rd October for this event, a JOTA badge and a special QSL card were also made.

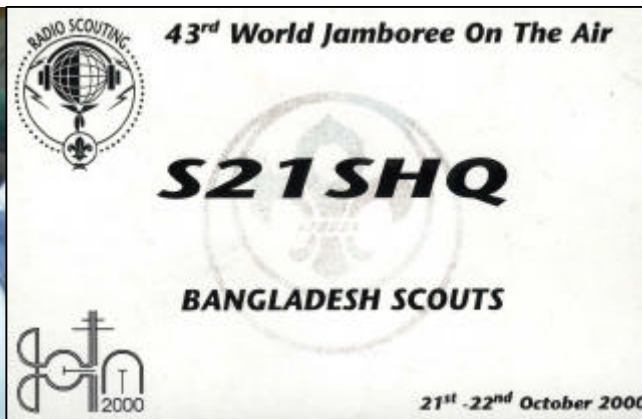

"S21AM this is Habibul Alam talking from S21SHQ the Club station of Bangladesh Scouts...."

Bangladesh Scouts could not log in to JOTI for problems of the landline in the campsite.

S21SHQ was present in the national training center of the Bangladesh Scouts, which is 45 kilometers from the capital city Dhaka. Bangladeshi participants talk with other scout stations about their program, hobbies, songs, national camps, jamborees, rover moots and also their excitement of having first QSO in their life. In between QSOs they were briefed about the Q codes, electronics, operating procedures, Morse code and the history and the development of the amateur radio in the world.

This was the first contact in the 43rd World JOTA, 1945 h Bangladesh Standard time (GMT + 6):

*CQ CQ CQ*

*CQ Jamboree, CQ Jamboree, CQ Jamboree*

*This is S21SHQ, calling CQ CQ CQ and standing by.*

... Alpha Mike

*This is S21SHQ, the official JOTA station for Bangladesh Scouts. QRZ?*

... S21SHQ this is S21AM, welcome in the world of amateur radio, you are five and nine. QSL?

... S21AM this is S21SHQ operated by S21D, QSL thank you for five and nine. We are participating in the 43rd world JOTA from the National Training center of the Bangladesh Scouts. Now I am handing over the microphone to the National Program Commissioner of the Bangladesh Scouts.

S21AM this is Habibul Alam talking from S21SHQ the Club station of Bangladesh Scouts and with this, Bangladesh scouts officially declare the opening of the JOTA 2000 camp at Mouchak.

... S21SHQ, S21AM returning

Congratulation to Bangladesh scouts and you my dear old man Alam.

During the JOTA, scouts planned to having a hike in the forest with portable radios in the afternoon and evening, but both the days there were heavy rain showers

with strong wind and the youths were living under the tents, so the hike was cancelled. Actually in mid October the rain is a regular phenomena in Bangladesh. On the final day there was a grand campfire, a certificate of participation was given to all the participants and special thanks to all the operators.

### Canada (VE)

participants:	2899
stations:	49
internet:	6
countries:	28

Lena Wong writes: In Ontario, the 1<sup>st</sup> Port Elgin Scouts were particularly impressed by talking to people who had actually been to see the Olympics. They learned several new skills, among them the ability to work out the best time of day to communicate with people living in other time zones.

Youth and leaders in Mission, British Columbia were hosted by the Mission Amateur Radio Emergency Service Society at the local fire hall.

Up north in the Yukon, thirty hardy souls braved their first snowy winter camp of the year and made it a truly international event by inviting an exchange student from Venezuela along to join the fun.

At Camp Tamaracouta in Quebec the 617e Ste Rose set up a radio station with equipment borrowed from the Government of Quebec Civil Security Services. JOTI activities were organized on four computers at three different locations, three with high-speed connections. They received a total of 1,085 e-mails from 45 countries.

1<sup>st</sup> Valleyview Scouts in Alberta participated in both events and made contact by radio in the USA, Ontario and Finland. JOTI took place at several locations. Problems were experienced with poor chatline etiquette. The Scouts preferred using the radio to the internet.

Back in Ontario, Whitby District held a District Camp in conjunction with a Youth Forum. The radio station was one of the forum events. The youth commented in 1999 that they did not want to participate in JOTI because nearly everyone had access to the Internet at home and could participate at their own pace.

The Beavers, Cubs and Scouts of 1<sup>st</sup> St. Andrew's, Newfoundland, had a great JOTA event combined with a family fun day. The biggest thrill was listening in on a conversation between a station in Italy and one in the Amazon Basin. The experience raised the awareness of the worldwide impact of the Scout Movement. Next year the group hopes to be able to set up their station at Signal Hill, the birthplace of Marconi's "wireless" in 1901.

A radio amateur permitted the McBride Scouts of British Columbia to set up camp on his property for a long weekend. Camp was set up in 50 km/hour winds which added to the adventure. Part of the weekend was spent in a Scouter's camper to stay out of heavy rains.





Porcupine District, Ontario usually has a great turn-out for JOTA. This year however, bad weather kept youth and leaders away. Those participants who did venture out to the camp included Girl Guides as well as members of both Canadian Scout Associations.



At Grey Wolf Scout Camp south of Thunder Bay, Ontario the 15<sup>th</sup> Fort William Scout Troop set up a JOTA station. Topics discussed were hobbies, family, pets, school and Scouting badges.

Nova Scotia's 8<sup>th</sup> Sackville were unable to participate in JOTA on the actual weekend because of regional events. As an alternative, they had a great time making contacts in Europe and throughout North America on November 25.

Manitoba's 1<sup>st</sup> Sun Valley Venturers operated outdoors from camp using HF equipment with an "inverted V" G5RV dipole antenna on a three section mast. A generator powered their

equipment. Several contacts were made on Saturday and Scouts from Winnipeg visited the station. Lots of fun was had gazing at the night sky between radio contacts and they spotted the new international space station with the space shuttle moving behind it.

Finally, in Ontario the Georgian Bay Radio Amateur Club opened their doors to the Owen Sound Scouts. On Friday evening the Scouts had fun learning how to solder or, more accurately, creating fascinating pools of molten metal. They also build crystal radio receivers. The day was finished off by building teepee shelters from bamboo poles, tarps and leaves.

### Chile (CE)

participants:	6500
stations:	65
internet:	0
countries:	26

Preparation of the event began in the month of June with writing of information pamphlet and asking for permission for the event, to the Subsecretaria de Telecomunicaciones.

We began Saturday 21 of October, with the check in of the present stations and the opening ceremony in the National Office, transmitted for all Chile by CE3JAM, as well as to other Latin-American countries. We enjoyed the presence of the executive director of the Asociacion de Guias y Scouts de Chile, Julio Pobles Comeratti, the Arcadion Scout group and representatives of the radio club of Carabineros, writes Isabel Carreño. Thanks to the excellent radio conditions, we could contact stations at large distances, like HB2S in Geneva and JA1YSS in Tokyo. On the Sunday morning a special hour was reserved for old-Scouts and -operators to transmit from the station.



At national level stations and situations were as varied as Chile's geography. In the north we mention the station of the port of Iquique, the one that was located with the "Rescue Boat", group which patrols the Chilean coasts in emergencies: the boys could be part of this service for a weekend, doing naval work interlaced with radio contacts.

In the centre of the country, in the sixth region in the town of Cuccorhue, another station was set up. Not only for participating scouts, but the whole town joined in by making a community party out of the JOTA event! This included participation of a factory of radio equipment and an exposition of Scouting and camping prepared by the boys.

In the Metropolitan area two stations are worth mentioning. The group "San Roque" operated CE3ETE from a converted truck, working all weekend from the east of Santiago.



Around the hospital, to the south, was the station of the district of La Cisterna that united boys and girls at CE3FZL. They installed a field-day station to be able to host more than 8 Scout groups. The leaders created an attractive program that included a visit to a factory of communication and many radio contacts.

In the south of the country we mention the station of the Austral University of Valdivia, CE7CLJ, and in Puerto Montt, CE7LEQ. The first one put all its facilities to disposition of the Guides and Scouts of this beautiful city; the boys profited from the nice location of the campus, located next to the river Calle-calle, while contacting the rest of the world. At the second one, the group 'Ardi Vargas' installed their station in a beautiful native forest.

### Croatia (9A)

participants:	157
stations:	4
internet:	4
countries:	27

This year we succeeded to maintain the high number of Scouts participating in the JOTA/I event and to increase the number of contacts and contacted countries, as a result of better planning and preparations, writes Vladimir Jurkic. Preparations started in August, when some of the JOTA/I material was translated into Croatian and distributed to all Scout groups. One month before the event, radio amateurs and radio clubs were contacted to help in the forthcoming event providing technical assistance and radio devices. Notice that almost 10% of the Croatian Scouts took part in JOTA/I activities, which is high percentage compared to other countries in the world.

No one of the Scouts has a license for radio communication, and officially they are not permitted to communicate over the radio. As the JOTA event is organized only once per year for a short time (two days), Scouts were permitted to talk over radio despite the fact that they are not licensed.

The Scouts in Zagreb took part in JOTA activities for the second time. During the JOTA weekend a JOTA camp was built in the mountain house Puntijarka on Medvednica Mountain near Zagreb. In front of the mountain house, radio amateurs and Scouts built a radio antenna. Their choice was excellent, as they succeeded to talk with Argentina, Iceland, Kuwait, New Zealand and Tunis. They also managed to equal the long-distance record talking to New Zealand's Scouts that was established in 1998 by Sea Scout group "Uljanik" from Pula.

The "Iovallios" group from Valpovo had 6 Scouts speaking with their scout friends around the globe, using 9A1KDE. They organized simultaneously JOTI activities in the nearby school where they were provided with PC computers. An especially long and fruitful contact was established with British Scouts at GB2ESG.

Sea Scout group "Uljanik" from Pula is the most active scout group in Croatia in the field of radio communications. They are the only group who took part in all JOTA events in the last 6 years. This year, they have also organized JOTA camp. They used the 9A1ACD call sign. The Scout group's headquarters are located in a large building where other civil organizations have their headquarters. Just one floor above the scout's headquarters there is headquarters of the radio club with whom they have established a long and fruitful cooperation in the past year.

The camp was not only a great opportunity for gathering a larger number of scouts who had a chance to learn and to try radio communication for almost two days, but also to promote radio scouting and scouting in general to the public as the field with the camp and HQ building is situated almost in the very center of the city. This was a great opportunity to show that the scouting is not only living in nature, but includes various aspects of the programme, including modern way of communication and technology. Many Scouts stayed awake for quite a long time talking to scout friends all over the world.

On Sunday, a scout competition in communication skills was held. Different patrols competed in traditional scout communication skills such as communication with Morse and flags (used on sea) and they took part in a communication quiz.



"...and our radio amateur is a nice guy...."



Probably the most interesting contact was made with Ali from Jordan. After a long talk about scouting in Jordan and Croatia, and exchange of scouting experience, our cub scouts sang a Croatian scout song over the radio. It was nothing unusual, as our younger scouts were singing to almost anybody they talked over the radio. After a minute or so, they heard the same song over the radio, this time from Jordan, and it was on Croatian! Jordan scout used his computer to record our cub scouts singing and then he played the song again over the radio. Contact with the same scout was made on JOTI event, and he was delighted when he succeeded to contact Croatian scouts over Internet. He also have sent the recorded song over the Internet back to the cub scouts, so now they can hear themselves singing, having a nice record from this year JOTA!

This year they succeeded for the first time to talk to JOTA organizers themselves by radio waves! They have contacted HB2S, radio station of the WOSM JOTA team situated in Geneva, Switzerland. A long and nice talk was made with Phil.

There were many Italian scouts on the air. Scouts from Savona and Sicily in Italy were interested in coming to the nearby Scout center at the island of Veruda that is managed by the Scouts of Pula. They have heard about the center from other Italian groups that already visited the Scout center.

### **Cyprus (5B4)**

participants:	800
stations:	13
internet:	0
countries:	16

Erricos Lanitis says that the Cyprus Scouts were very pleased to take part in the JOTA, as every year. They enjoyed having contacts with other Scouts. To note that all the participating stations were active in both JOTA and JOTI.

Erricos was live on the air on broadcast station Radio Helios for 10 minutes to explain the JOTA event. He also told the listeners where the JOTA stations were located. Radio Helios can be received all over Cyprus.



Cyprus Scouts ready for action.

### **Czech Republic (OK)**

participants:	312
stations:	52
internet:	0
countries:	66

Radio station OK1GW/J was, as usual, the best in the competition. This pure radio scout station was manned by 6 operators who kept operating for the full 24 hours of the day. The most interesting QSO was also achieved by this station, namely a QSO with Ukrainian Scout radio station UR4VZE in Sviatlovodsk, operated by a 10 year old boy scout Jurij (George) who was a very skilled operator with fluent English. Jurij was able to answer all our questions about the Scout movement in the Ukraine. The second operator of UR4VEZ told us later in another QSO with OK2KEF/J that he had been in Prague, capital of the Czech Republic, with a group of Scouts in 1997.

Another interesting QSO was between OK2RSB/J and Norwegian LA8RU, operated by 78-year-old Tormod who is a Scout active for the long period of 64 years.

We had even the opportunity to listen to a native African song performed by a young Nigerian Scout during the contact with 5NOBSK.

Unfortunately the General assembly of the Czech radio amateur Society was held at the same time as the JOTA, so the Central radio scouting Station OL5SCT was unable to be on the air all the time, concludes Jiri Hold.

### **Denmark (OZ)**

participants:	450
stations:	46
internet:	13
countries:	31

Once again, JOTA in Denmark was a success, starts Brian Lodahl his JOTA story. Despite the usual logistical problems almost every station signed in was QRV, and joined the rest of us for a nice weekend.

Giving the great conditions during the weekend, the amount of long-distance contacts and long-lasting contacts on JOTA was greater than last year. This was supported by the fine reports coming in from around the world. Already on Friday night, many of the radio amateurs spoke about the fine conditions on the upper HF bands, so we were excited to get the rigs set up and try





for ourselves.

JOTI was fortunate an increase in participants, giving the rising popularity of this technology combined with the relatively easy access to this media.

The opening speech was given by Maj-Lis Grarup, the Executive Scout Chief of the Danish Baptist Scouts and Guides Association. She spoke about the essence of common understanding between people of different cultures. To accept and respect people as they are: equal. This is important to remember in international Scouting and Guiding. Immediately after the opening speech was broadcasted on the 80m band, the speech transcript was put on the internet for everybody to read:

OX3NUK from Nuuk, Greenland participated in the weekend. This year, they had expanded their activities. The scouts and radio amateurs had established a second station on the Telegraph Islands, working the HF and VHF bands with call sign OX3JOT.

As usual, the scouts and radio amateurs met for a ring-QSO on the 80m band on Sunday morning. During the entire QSO, around 18 stations participated, topping at 14 stations simultaneously! At the time, OZ3ANT,

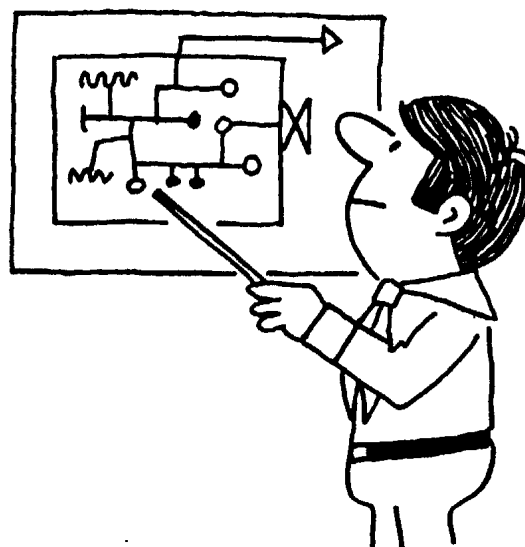

Electronic kit building: "solder the green wire in the round hole and the blue wire to the battery..."

Carsten was managing the ring, but desperately needed to have a coffee break. So as I came along, he said: "Here you go, have the mike. By the way, you are in control of a ring QSO, have fun!", and he went for coffee. Wow, what a busy job that was. The entire sked lasted about 1,5 hours and everybody had fun. This event will definitely take place again next year.

In our report we usually have an electronic building kit. This time, the kit is based on the concept of the 1998 material regarding land mines. The material was created in co-operation between WOSM and Handicap International.

Even though combining the JOTA and JOTI activities do cause some practical problems, it seems that this probably is the best way of doing things. About half of the participating Danish stations use both technologies together. I fortune the combination of the two events to be a big hit, Brian says, and above all an increase in the possibilities we offer the Scouts when it comes to International Scouting. I think, in either way, this would have pleased Baden-Powell.

Feedback from the scouts also indicate, that we should try to create games suitable for co-operation between the two media's, that is; try to come up with games, that would require use of both technologies working together. This would in greater extent reduce the boundaries between the two technologies, causing the scouts to focus more on the aim of the event rather than the tools used for reaching the aim. Who knows? Maybe in a few years we will see new methods of communication emerging and they too will be used in the weekend as well, concludes Brian.



## Finland (OH)

participants:	50
stations:	12
internet:	4
countries:	24

Markus Hamro-Drotz emailed us the following: OH2JAM was operated by the Radio Club of Kauniainen's station OH2NRG. We had two operators: OH2LRE and OH2JRR. A local scout group, called Grankulla Scoutkåren, visited us. They were 10 boy Scouts and two leaders. The scouts were given an introduction to radio amateur hobby and they practised some Morse code. We had also more than 60 QSOs, mainly to Europe and USA. Some of the scouts talked also to Holland and some places around Finland on the radio. Having a voice contact abroad was very exciting for the scouts. The JOTA-bulletin was given by Heikki, OH3IF to all Finnish JOTA-stations on Saturday.

## Germany (DL)

participants:	1020
stations:	45
internet:	4
countries:	45

Lars Weimar (BdP) writes: 8 stations taking part in the JOTA. Some of the groups made contacts with both the internet and radio. The new way to communicate over the internet included the contact with the soundcard and microphone. One station spoke online with another in this way. Many webcams and digital cameras were used to send greetings. The only bad thing was the WAG amateur radio contest in Germany which makes it hard to speak to other scout stations.

The Buchhorn scout group in Friedrichshafen developed a special antenna for JOTA, reports Klaus Sperling (DPSG). It was called "Scout roof". The design was printed in the amateur radio magazine CQDL (10/2000)



Bild 4: Aufhängung des Pfadi-Daches

and received admiration from the experts. The Scout magazine "Zundstoff" held a JOTA logo competition.

The headquarter station DK0BS operated from the National Training Centre in Westerlo. At the same a training course on international aspects of Scouting was held there. The participants used the opportunity to experience international radio contacts with Scouts themselves.

The number of JOTI participants is difficult to estimate, says Klaus, because of lack of reporting from JOTI stations.

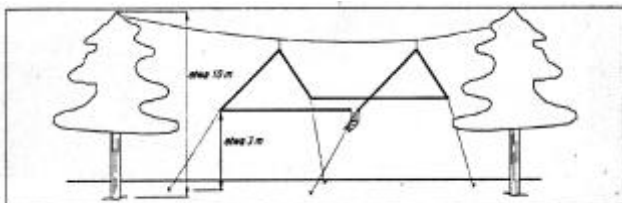
Again this year, the German radio-association DARC sponsored 2.800 envelopes and stamps to send a 16-side JOTA/JOTI-booklet to all scout groups in Germany. The booklet informed groups how to organize a JOTA/JOTI-weekend and gave information about these national activities:

- Kitbuilding;
- DL-sked on Saturday afternoon, a party with all German radio-scout-stations;
- DL-sked-Game, a panel game in several parts during the DL-sked, where a telephone-number was to be found;
- Packet-Radio DL-Convers-round the whole weekend, where scouts can type messages to each other;
- Packet-Radio Game, to find 3 messages in 3 different mail-boxes somewhere in Europe;
- Puzzle-Game in three parts on the 80m-band;
- A new Communication-Game, connecting JOTA and JOTI.



"I could have sworn he was right here....., or wasn't he?"

The Communication-Game: some scout-groups only take part in JOTA, others only in JOTI and a third group joins both events. An 18-line long old DPSG-song was given in separate lines to all preregistered German scout-groups. The aim was, to find out the whole information by contacting other scout-groups. It was an interested experience as the lines jumped from amateur radio to internet and back. On Saturday evening the first group reached the aim.

DF0GSN, VCP/DPSG-Grevenbroich, organized again a campsite together with other scout-groups from Dornagen, Dortmund, Duesseldorf and Hoexter. After their solid preparation with a special 2,4 GHz Link to the next town for an Internet-connect and high quality amateur radio equipment, during the JOTA/JOTI-weekend they were visited by a special guest: Mr. MURPHY!!! Internet – no Link; Packet-Radio – cable missed; HF-

antennas – bad SWR; HF-antennas and transceivers changed – no signals. But in spite of all: HB2S in sstv-mode reached and the traditional 2m-ssb-contact over a distance of about 300 km to the VCP-Funkergilde in Bremen worked excellent.

In May 2001 the German RdP-radio-scouts will meet in Lindersberg. Themes are: principal way, how to organize JOTA and JOTI as one event; looking for common activities in German-spoken countries, running a radio-station, concludes Günter Erdmann (VCP).

### Guyana (8R1)

participants:	53
stations:	3
internet:	1
countries:	26

The radios were operated by members of the Local HAM Club, but we were allowed to speak. Even though about 6–8 Scouts were crammed about a single computer at the JOTI station, set up in the Scout Room of the St. Stanislaus Scout group the youngsters had

fun.

A total of about 27 Contacts were made by radio; we were disappointed that we could not make contact with the World Bureau and Gilwell Park, but we had particularly good contacts with Scouts in Curacao, Suriname, Trinidad and USA. We exchanged ideas and greetings (Scout Yells) and even sang a song over the radio. Scouts of the St. Stanislaus Scout group had a “Sleep-over” at their Scout den from Friday 20 to Sunday 22



"welcome to the 43<sup>rd</sup> JOTA in Guyana...."

and were able to make contact with 72 different individuals from 26 different countries.

Scouts are being encouraged to continue to keep in contact with their new Scout penpals. The experience all in all was good for all that participated, particularly regarding the JOTI, as many young people do not have access to computers in Guyana. Many of the Scouts feel that JOTA/I should be held more frequently.

### Hong Kong (VS6)

participants:	6000
stations:	?
internet:	?
countries:	?

We organized the 43<sup>rd</sup> JOTA and JOTI at the Gordon Wu Hall of the Hong Kong Scout Centre with a sub-station in the Hong Kong Island Regional Headquarters.

This year, we invited Mr Eddy YAU, JP, the Acting Deputy Director of the Leisure and Cultural Services Department of the Hong Kong SAR Government to be our official guest and he gave a speech in the ceremony as a start-off of the whole programme.

Our youth members were able to operate wireless transceivers to communicate with local and overseas Scouts. Participants were also taught how to use simple equipment to perform different ways of communication like Morse Codes, Standard Phonetic Alphabet as well as communicating through wire and cords.

Games relating to communications, such as decoding of Morse Codes and the Semaphore Signalling were also designed for participating Scouts.

Scouts could also have a live conversation through video conferencing on internet to share and exchange their ideas. Information on “Computer Security” and “Guide to Protecting Children on the Internet” provided by the Crime Prevention Bureau of



Morse code.

the Hong Kong Police was exhibited in the event for arousing Scouts’ awareness of these importance topics.

A boot for silk screening was set up for participants who wanted to have this year logo for JOTA/JOTI on their T-shirts as souvenir. Scouts could also get their own photo stickers with Scout leaders helping them to take digital photos camera and developed the photos by computers on the spot.

Each participant got a souvenir badge if he could complete both Amateur Radio and Internet Games and one activity at any Game Stall.



Print your own JOTA T-shirt.



## Iceland (TF)

participants:	
stations:	
internet:	
countries:	

For the first time the Icelandic Radioscouts, were able to run four JOTA stations. Two of those stations were JOTA only and two were JOTA and JOTI together. In the mixed stations scouts and guides were running some programs during the weekend and having a good time speaking to each other and to some foreign scouts and guides, writes Konrad

Thorisson.

The Chief scout of Iceland, Olafur Asgeirsson, opened JOTA in Iceland with a speech early on Saturday morning. One of our stations talked to HB2S. And from TF1JAM at our scout camping center at Ulfljotsvatn, we managed to talk to Les Mitchell in UK. That contact was the greatest we made this JOTA and Les was quite happy too. Icelandic National Television visited TF8JAM and sent out news about what scouts were doing in the main news broadcast on Saturday evening. This news interested many people and was a great advertisement for scout activities. The youngest scout we talked to was a six years old boy in UK and probably Les was the oldest one.

The Icelandic Radioscouts were very happy after JOTA 2000; this was the best JOTA ever. And many of the radio amateurs that helped us said: "this was great, I want to do this again!".

## Ireland (EI)

participants:	?
stations:	?
internet:	?
countries:	?

EI5MRC is a permanent station attached to the Scout Centre at Mount Melleray Abbey in Cappoquin, says Pat Geoghegan. JOTA 2000 was definitely the most enjoyable event of the year for both the Scouts and the

Amateur Radio operators. Almost every one of the 80 Scouts got on the air with Scouts from another country. On Saturday afternoon, Radio conditions on 40 Meters were amazing, we had deep and rapid QSB (fading of Signals) as we talked with one station they disappeared to be replaced with another in a different country, the Scouts were amazed to hear the operators say, Good evening - Norway - Finland - Germany - Malta - Denmark - Iceland - Greenland.

We were naturally very happy to work HB2S - Richard, in the opening minutes of JOTA on 40 Meters. Our Antenna was a W3DZZ, held up at one end by a mobile crane, it was at 150 Feet sloping West to 40 Feet off the

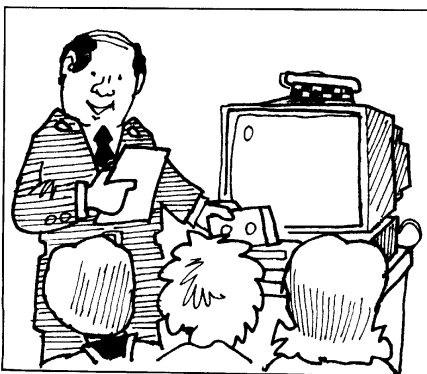

ground. We worked VK6SZ/J in Kalgoorlie, WA, Long Path; we are still working out the miles from Kalgoorlie to Mount Melleray via the Atlantic Ocean - USA - Pacific Ocean - Atlantic Ocean, on 100 Watts and a wire Antenna, that was just brilliant.

In the Northern hemisphere we worked TF1JAM in Ulfljotsvatn, the operator Vala was kept very busy but she handled it in style, well done Vala. And finally we had much pleasure working OX3JOT, the Scouts on Cook Island, South of Nuuk - in the South Western part of Greenland. We spoke with the Operator "Brian" and Scouts "Avijaja" and "Fredereike".

The Weather was very nice on the Saturday, brilliant sunshine but on the Sunday we had torrential rain and very strong winds, our main Antenna was blown down and finally at 06:00 on Sunday we lost our main power supply. We finished with just 1 of our 3 HF Stations still operational.

## Japan (JA)

participants:	513
stations:	73
internet:	26
countries:	12

Nippon Boy Scout Amateur Radio Club JA1YSS operated their station at the National Headquarters of the Boy Scouts of Nippon with 22 operators. They could contact 197 Scout stations in 12 countries during the JOTA. The Boy Scouts of Nippon provided a guest-book on our web page for JOTA/JOTI communications, and more than 270 Scouts and leaders wrote messages on the guest-book. It was reported this year again that many portable stations were operated during the JOTA such as in mountains, at banks of rivers, at Scout halls, at outdoor activity centres.

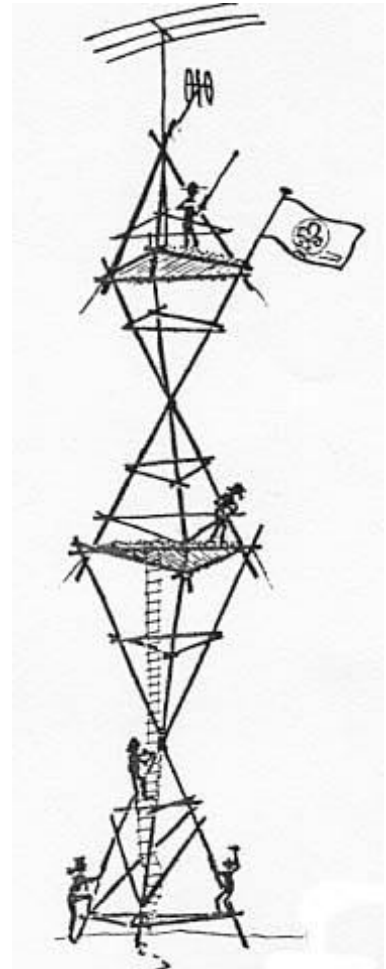

Before the JOTA, the Boy Scouts of Nippon circulated the information to Scouts and leaders on the 43rd JOTA through our local Scout councils, Scouting magazines and JARL News.

The club members of the station JA1YSS had a meeting and shared information on the JOTA during the JARL Ham Fair 2000 in Tokyo in August. They also had a preparatory meeting for JOTA in Nara in September, reported Toichiro Nishiyama.

### Mexico (XE)

participants:	45
stations:	1
internet:	0
countries:	6

The official Station of the JOTA was placed in the Geology Institute, says Xochitl Prado Serrano. We started our communications on Saturday 21<sup>st</sup>. At 7:00 hours and the National Scout Chief held a speech. The station was operated by the scout group 76 "Amanecer" and Rovers of scout group 251, helped by José de Jesús López V. XE2AVI and Alfonso Belmar XE1ILH.



"Pssst, don't tell him that...."

Brownies and cub scouts started in the morning, Scouts in the afternoon, rovers all night. In the JOTI we were helped by Gabriela Balderas Platta, mirc operator. We had 49 contacts, three of them with an official station: Boy Scouts of America, Belize and Peru. Others contacts were with Portugal, Costa Rica, Peru, United States and Mexican Republic states. We enjoyed this activity and even more so the brownies and cubs because they discovered other forms of communication and they have new friends now in others cities. We made a logbook with contacts, games and technical cards, pines, posters, pens and patches.

### Namibia (V51)

participants:	?
stations:	1
internet:	1
countries:	?

The 1st Tsumeb Scout Troop (Namibia) took part in the 43rd World Scout "Jamboree on the Air" as the only Scout Troop in Namibia, using the callsign V5TSB. Across town at the local Internet Cafe, the Troop's six senior Scouts (patrol leaders and assistant patrol leaders) joined Tsumeb's Girl Guides in writing e-mail messages to Scouts, Girl Guides and uniformed leaders in 18 countries. In the process they collected a lot of names and addresses to begin pen-pal relationships.

At the radio shack, the Scouts exchanged greetings and compared Scouting notes with fellow Scouts around the world. Working two at a time in two-hour shifts, they recorded every contact in a logbook and pinpointed each station on a large world map. The highlight of the weekend was a contact with the World Scout Bureau (HB2S) in Geneva, Switzerland, on Sunday morning, Oct. 22. Jim Kastelic writes: "just after our chat, I drove from the radio shack back to the Scout hall to check on all the scouts. There they were, all huddled around the receiver we previously set-up. They had heard every word of our conversation! So, in effect, the whole troop got to "meet" you in far-off Switzerland without leaving town".



The crew of V5TSB.

The Scouts camped out at the 1st Tsumeb Scout Hall for the jamboree, beginning on Friday, Oct. 19. They built proper patrol campsites that featured cottage tents, camp kitchens, fireplaces and practical camp gadgets. Every couple of hours, due to the fact that it was sweltering hot (40 degrees C and above!), they

headed over to the local swimming pool for a refreshing swim.

During the camp, the Scouts received training in energy conservation and undertook several projects dealing with the use of solar power (a perfect weekend for it, as it turned out!). These included making modified "hay boxes" and cooking rice in them. First, the Scouts lined a number of cardboard boxes with several layers of

newspaper. Next, they put rice in a pot of water and brought it to the boil on their cooking fires. They immediately removed the pot from the fire, put it in the middle of the hay box, packed crumpled newspaper all around it and put a square of foam rubber on top of the whole thing before closing up the box and leaving it for nearly five hours. At supper time the box was opened and the pot removed. To the Scouts' surprise and delight, the rice was perfectly cooked and prime for eating!

### **Netherlands Antilles (PJ)**

participants:	330
stations:	1
internet:	0
countries:	14

Once again it was a fruit-full weekend, says Hubert Martha. Having a camp at the university is amazing. We had a weekend program where we involved all cub scouts, leaders and ex-scout leaders. We had some great workshops on new Scouting materials, sport activities and an expo of Scouts that went to the World Scout Moot. A group also gave a demonstration of how well their sales abilities are by selling more than 100 hamburgers and tacos. For the first time, the Scout groups of Bonaire joined us here on Curaçao for the JOTA.



Now where do I find this page with badges?

### **Netherlands (PA)**

participants:	?
stations:	269
internet:	44
countries:	?

Jan Kluiver writes us that a well-known Dutch artist was willing to open the JOTA.. A little later the text and audio-files were also available via the internet.

This year we started with registration for JOTA as well as JOTI via the Internet. In total 313 groups signed up: 269 for JOTA (and JOTI), 44 for JOTI only. From all registrations 54% was received via Internet. The use of internet during the JOTA has stabilized amongst JOTA stations. We are pleased about the way the internet has settled in the JOTA event, says Jan, filling up the gap, not overshadowing the original JOTA.

The Vaandrig Lengton Scout troop celebrated its 90<sup>th</sup> anniversary with an extra large JOTA station, including a small satellite station on the Peperbus-toren, the famous tower in the city of Zwolle.



"... and then my bike fell in the mud..."

Another exceptional station was the Wielewaalgroep from Eindhoven. They located their JOTA-station in the Second World War museum "Wings of Liberation" in the nearby town of Best. They invited a club of old army gear enthusiasts. The JOTA station operated on Second World War equipment. While in HF-contact with PA00SS/J you could hear the generator in the background increasing its revolutions per minute. All activities were in the theme of the liberation of Eindhoven in 1944.

Thomas More PA3AJ/J: at 07.00 hours there was a sked with a station in New Zealand, so we needed an early rise. Unfortunately the contact didn't materialize, but we did contact

another JOTA station in New

Zealand, ZL1BOS, with the Taupiri Girl Guide group.

The St Jorisgroep in Westervoort PB0AOA/J had contact with a scout troop from Leuven in Belgium. After a nice contact the Belgians asked if they could hand over the QSL-card the next day. The next day 2 leaders showed up, after travelling 200 kilometer. Scouting Scojesa in Sassenheim reported a similar visit, possibly the same group. Scojesa promised that if they would meet again next year in the Air, they would visit Belgium.

Scouting St Stanislaus Kostka PA3GMB/J in Veldhoven reported enthusiastically the receipt of SSTV pictures from a Japanese JOTA station.

The largest antenna tower was built by the Flevo-Scouts in Dronten PA1WPL/J: 45 meter.





## New Zealand (ZL)

participants:	?
stations:	?
internet:	?
countries:	?

Jim Parnell writes: again, I had a zero budget which limited the amount of publicity that I could promulgate regarding the event. In addition, this year JOTA clashed with our Labour weekend (Labour Day is the 4th Monday in October). Participation in JOTA's on Labour Weekend has never been as good as those on the weekends when there is no clash.

However, there was quite a bit of JOTA activity in New Zealand this year. Present of course were the stalwarts, who are on year after year; what would we do without them! The JOTA camp at Camp Maynard was shown in a 5 second video bite slipped into a TV news report on recreational activities around New Zealand for the long weekend. The most exotic contact was with MIR. New Zealand's National System, which links most of the country with a 70-cm "party line", was very busy during JOTA. Unfortunately due to poor propagation conditions, overseas contacts were few.

## Norway (LA)

participants:	1130
stations:	51
internet:	10
countries:	34

The Norwegian JOTA was held in a traditional fashion. The Norwegian main station, LA1JAM, was situated at Grønmo, Svartskog, at the facilities of the Follo group. LA2RR Ole Garpestad, LA2JR Christian Aashamar, and LA1SP Hans

Petter Østrem operated the station. The 3rd Kolbotn scouting group was also

present. The official part was launched by a joint Nordic opening, which started with a Nordic joint broadcast at 07:50 UTC and a Norwegian opening at 08:15 UTC. The Norwegian opening was coordinated by LA1JAM, and was then passed on to LA2BBA, where the vice scouting chief held the official opening and greeted the participants on behalf of NSF, writes Dag Anders Kjærnes.

Reports have stated that it was particularly quiet on the radio on Saturday, between 12:00 and 15:00. Other reports stated that at the same time there was extremely high activity on the Scoutnet IRC servers.

This year's JOTA/JOTI appeared to be smaller than last year's. This may have been caused by the invitations, which were not published until May.

Conclusively, we can consider the event as positive for those groups that participated. But I sense the need for renewal and the increasing need for service and customizing the services to each particular participating group. Unfortunately, this requires more resources and different ones than what we have available today. This applies in particular to activities that are organized without the help of external sources, e.g. most of the JOTI activities.

## Peru (OA)

participants:	1748
stations:	21
internet:	32
countries:	?

Luis Hinojosa Pacheco writes us from Lima: The radio interest in Peru is decreasing little by little and for the Scout



".. eh, hello, can you hear me?"



"hola todos, aqui esta Peru..."



Internet via Comsat.

groups it is difficult to obtain a radio ham, for that reason the groups look for easy to obtain that public cabins, a place in which any person can rent a connected computer to Internet and to a low price. It is why most of participants in the JOTI it has been through these public cabins.

To participate in the JOTA in the provinces, it is more difficult than in Lima to obtain radio equipment, in spite of all this, in most of cases they obtain the radios, but do not find a radio amateur with a license. During this year we worked with institutions of prestige that supported to us during the event, like the Peruvian Radio Club (with which we have a standing agreement, and they lend its facilities and radio station to us). And with the Radio Club PUCP (Pontifical

Catholic University). Arrangements are being made to sign an agreement. They supported to us with radio equipment connected to computers, with which packet-radio could be run. Furthermore the Peruvian Red Cross, Lima section (it offered us its facilities, radio station and operators).

For the JOTI we were supported by the Instituto Idea (an institute of enterprise development, with much experience in Internet. With this institute we have an agreement of mutual co-operation allowing us to use its facilities for Internet). Also with COMSAT S.A. (that offers satellite connection for us to internet) and with Regatas Club, Lima, that lent the facilities of its internet laboratories and installed an additional radio station.

### Poland (SP)

participants:	260
stations:	48
internet:	0
countries:	39

The headquarter station SP5ZHP operated from Losice, in east Poland, writes Jan Ladno. Some 200 scouts were present there. They used amateur radio bands as well as private channels of the polish Scout Association. At the end of the weekend they held a foxhunt. An interesting contact was made with a Russian ship, moored in the harbour of Gibraltar.

The Scouts in Rawicz, on the air with SP3ZHW, organized a competition with about 80 VHF and UHF stations. Every participant with more than 43 contacts obtained a special JOTA certificate.



Mobile JOTA station.

### Portugal (CT)

participants:	9582
stations:	9
internet:	1
countries:	49

José Augusto Marques Joaquim (CNE) writes: JOTA has been an opportunity to celebrate, the *Peace Culture*, the Portuguese theme which was the principal subject for all the stations participating, and also the subject of the Portuguese game. In Portugal, JOTI becomes very popular in scout groups as well.

C.N.E. HQ station CT8CNE, was located in Núcleo do Douro Sul, in Vila Nova de Gaia city, on the left border of the river Douro.



Packet radio: digital contacts on the air.

As usually the other stations operated from all over the country including the Madeira and Azores islands, in public places but mainly from the troop's headquarters.

QSO's are mainly on VHF, especially for cubs and scouts until 12 years old, because of their difficulties in understanding the English. The oldest Scouts, Rovers and of course Scout Leaders are mostly interested in DX QSO's and this year the "Santa Propagation" helped a lot.

As said in the introduction, this year we had created a special theme for JOTA and JOTI. It's easier to have a common ground so everybody could be on the same "frequency" and talk about the same subject. It was a surprise for us, because all the scout troops took the subject very enthusiastically, and as you will see lots of good activities were developed around this subject.

The opening ceremony took place in Villa Nova de Gaia, at the CT8JAM station. During



"CQ, CQ, CQ Jamboree....."



the ceremony, the C.N.E. National Scout Leader, Luís Lidington said among others: "Being in peace means listen to understand, preserve the planet to rediscover the solidarity..... Could all Scout and Guide

Movements be bearer of life projects to children and young people ... .. and so we will be creating new men and a new world."



CT7NMV like last year, operated from the Arboreto house near the Vasco da Gama bridge, on the right bank of the Tagus river; they had more than 350 scouts and girl guides in their activities, and were very pleased to make a QSO with HB2S. They are very interested in the CW mode: they tried to send their own names in morse code.

CT7JRB located in Santiago do Cacém, reports, “ we have a lot of fun contacts on HF, and also via Internet, where we had contact with scouts on Spain, Brazil, Venezuela and of course Portugal”.

CT7ASN in S. Nicolau shared their station with five city troops, and enjoined different games prepared by their leaders, and scouts had opportunity to send their own messages in which they had to include the words: Peace, Scouting, BP, Friendship and Fraternity.

Celestino Martins (AEP) adds: this year the Scout groups received all the information via email and by consulting our web site. We organised some big regional stations; in Lisboa we had a station with 500 boys, in Cascais the JOTA station was installed in a big circus tent with 623 Scouts and Guides from the 3 Portuguese associations. In Caparica there was a Scout camp with 160 Scouts on the air and in Guimaraes another 160 Scouts joined in.



CT7NMV close to the Vasco da Gama bridge.

The AEP National station CT8AEP was installed in Olhão, near the sea. In a tent of 300 m2, 325 Scouts enjoyed the JOTA. They had two extra receivers to listen to the radio traffic and could ask the operator to respond. A representative of the State Secretary of Youth opened the station. All stations organised activities like Scout plays, designs, sculptures, traditional games and nautic activities.

### Romania (YO)

participants:	92
stations:	8
internet:	1
countries:	23

Niculae Daguleanu reports that there was no official participation by the Romanian Scout Association. Few stations were active as individuals. YO3KPA operated from the "School

of children and students". Another one ran from Campia Turzii with

YO5OHO and YO5ONI. They contacted DL2AIL who spoke Romanian and wanted to know everything about the group. It is always rewarding to see the Scouts ask a question in English and to get an answer back. You can see them think: " I did it". They contacted HB2S in Geneva via packet-radio. The mayor of Turzii, mr. Hanga Radu, visited the station and was impressed with the activity.



"And now I give the microphone to the Scout here...."

### South Africa (ZS)

participants:	?
stations:	?
internet:	?
countries:	?

Dave Gemmell writes in his report: "I have already started investigating the possibility of having Hams stations transmitting JOTA or Scouting News in the 160 and/or 80 meter Ham bands using the AM (DSB or A3E) mode. Hopefully more Guides and Scouts will be able to listen in using household receivers."

The most active station in Goldfields was ZS4BOY at run at the 1st Dagbreek Scout Hall in Welkom. Here a Fun Day was arranged for the Cubs and Brownies which many attended. It was said that most of them, if not all, spoke on the Air.

The local Bloemfontein Hams manned a station at the Bloemspruit Air Force Base and used the special event callsign ZS80SAAF at the Air Show which was in progress at the time.

Carol ZS5YG, the ham who has been running the JOTA station at Amamzintoti for the Amanzi Ranger Guides, celebrated 20th Anniversary of JOTA at Kingsway Guide Station. Carol says that he believes that they were the first Guides JOTA station in South Africa and remained the only one for a number of years.



One of the 37 Springvale Scouts at the mike.

Thanks to Willie ZS5WI, the 1st Eshowe cubs were again able to take part in JOTA 2000. Willie is the JOTA Co-ordinator for Zululand (northern kwaZuluNatal) and he concentrated on 40 meters as to ensure that reception was clear as possible for ears unaccustomed to SSB. Unfortunately the weather was against outdoor activity, especially for ten "hyperactive" cubs! Jess Wison, the Eshowe Pack Scouter, has come up with the idea to help the boys overcome their shyness when using the microphone: get them to practice by using a tape recorder.

Pietermaritzburg Guide station

ZS5PMB was on the air operating from the guide camp World's View, a very high point just outside the City. They used an international theme and named the patrols into which the girls were divided with the letters of JOTA/I. Hence, Japan, Oman, Tanzania and Italy. The girls enjoyed doing the following activities; talking on the air, learning morse code, Fox Hunting, making a crystal receiver, using QRP (low power) transmitters, and other guiding activities. Contacts were made with Kuala Lumpur, Perth, Taiwan, Pittsburgh, Pennsylvania, and, for the first time ever, Mozambique.

These young ladies are the only ones who report any activity on JOTI. As it was the Guiding's 90th Anniversary they aimed for 90 JOTI contacts and ended up with about 100!

ZS6MUS was run from the Radio Room of the "Friends of the South African Air Force Museum" at Swartkop Air Force Base just south of Pretoria. The Guides of 20th Lyttelton and 8th St.Albans Companies spent Friday Night in the cargo hold of a Transall aircraft and spent most of Saturday passing Guide aircraft badge.

The 37th Pretoria (Springvale) Cub Pack ran a JOTA special event station (ZS37SS) during their "African Adventure" camp at Gilglen, the Pretoria Scout Training Grounds. Although "excessive" rain fell over the weekend, contact was made with numerous JOTA stations. The best DX were two lengthy contacts which were made with 5R8ET (Solofo) in Antananarivo in Madagascar.

Jason Webber, a Cub with 37th Springvale, wrote: "Our callsign was ZS37SS and my dad Ray Webber operated the radios and was in charge of our JOTA.I want to get my radio amateur license so that I can help operate a station one year. We all got JOTA 2000 badges which we can wear on our uniforms for six months."

4th BENONI air Scouts ran a JOTA station at Arroe Park, another Scout Training Ground at the town of Benoni, about 20 kilometers east of Johannesburg. This JOTA Station represented 7 Troops. Nigel was on HF and Dave on VHF/UHF nonetheless they had to ensure quite a distance between their equipment to avoid interference between one another. Contacts were made with Australia, China, Malagsy Republic, and two special event stations in the UK, GB0HDS and GB2COS.

The 1st Middelburg Guide Company and Scout Group asked Radio Hams to arrange their annual JOTA station. The Ranger Guides built a mast for the antenna. Using an ICOM IC226 into 40m dipole at a height of 5 meters, Dave Stoltz ZS6BXN contacted a number of local JOTA stations and A47JOTA Muskat Scouts and Guides, Oman.





## Sri Lanka (4S7)

participants:	400
stations:	7
internet:	0
countries:	?

Mr. Gunaratnam wrote us: radio scouting and JOTA are an excellent venue to meet Scouts and Guides from our country and also from other countries. We contacted the Chief Scout Commissioner, dr. Philips, in Kerala, India. Also we had contacts with Hyderabad in India and with Mr. David in Australia. The Sri Lanka scout headquarters had set up a radio station for JOTA.

## Sudan (ST)

participants:	8
stations:	2
internet:	0
countries:	5

Magdi Osman Ahmed writes us: the Scouts were very happy to take part in the JOTA, which was arranged for the third time in cooperation with the Sudanese Amateur Radio Association "SARK" and the Sudan news Agency SUNA. Participants and visitors were the Khartoum sea scout troops and the Khartoum Aeronautical scout troop, the scout masters and the Sudan news agency, eng. Elderdieri, and the chief of the Amateurs, Dr. Sid Ahmed, ST2SA.

Before the event an intensive training in theory and practice was given, especially on phonetic alphabet, prefix of countries, Q codes signals and station visit.

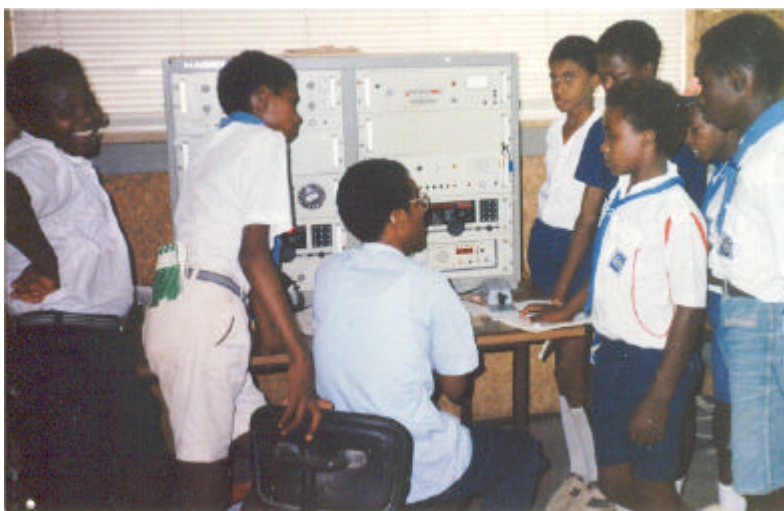

"look guys, if I now pull this switch then we are on the air.  
Are you ready?"

The most exciting two contacts: Martha HA5FQ in Hungary; we heard the call sign at end of the first day of the OTA at 19:28 UTC, and this hearing gave the station a new sprit. We contacted Martha, first we were exchanged the reports, and the senior sea scouts of Khartoum gave her the greeting and told her about the rowing boats hike from the sea scout centre in Khartoum at the west bank, over the Blue Nile through the 6 cataracts on the river Nile to the town of Shendi, 185 kilometer north of Khartoum. They spent three days on the boats, contacted the people at both banks, and practiced night navigation

The second exciting contact was mr. Bill ON5GQ in Belgium. He told me to stay on the same frequency and I think he was making alarm for all stations, and after a few minutes, I am surrounded by hundreds of radio stations, every person wanting to make a contact with me. I made contacts with stations in Belgium, Kuwait, Italy, Finland, Malta, Germany, Spain, Denmark, Portugal, Czech Republic, Poland, Estonia, Luxembourg, Brazil, Japan, United States of America, Canada, Norway, Azores. Is., Ukraine and Russia.

This is a good chance for ST2BSS to support the members to improve the hobby and to help the communities in emergencies. The communication's laws don't give much chance for the children to get in touch with radio. This is the third year that the scouts were permitted to get on the band for the JOTA Program. But the important thing we must work better to train the young scouts for "amateur radio" and prepare them for such situations.

JOTA 2000 was great. The most important contact was with HB2S, operated by Phil LX2AJ, the station of the World Scout Bureau.

## Surinam (PZ)

participants:	35
stations:	3
internet:	0
countries:	9

Our JOTA activities started on Friday night at the national headquarter in Paramaribo, in cooperation with the association of radio amateurs. We had two other stations in the outskirts of Paramaribo. At the headquarter grounds, Scouts of three groups camped in tents. Inside the den, Scouts could enjoy



themselves too with the facilities of internet. Our JOTI activities were not as successful as hoped for. Chief commissioner Baltus Oostburg and headquarter commissioner John van Dillenburg did visit the two other stations and could speak with scouts from abroad.

Many of our Scouts are not very proficient in English or Spanish, and with a microphone in their hands, they kind of freeze ... (Our official language is Dutch)

### Switzerland (HB9)

participants:	90
stations:	9
internet:	0
countries:	36

Great news comes from Switzerland this year. It was a long way to go, writes Jürg Hebeisen, but just before the

JOTA we received the permission to put Scouts at the microphone. It took many letters and a lot of energy, but we got the good news. [Congratulations to Jürg and the Swiss Scouts. Ed.].

We expected that many Scouts would now jump to the chance, but that didn't happen. Not all of them dared to have a go, not even when speaking in the same language. The Scouts clearly had to get used to it, also to the spelling in the phonetic alphabet.

Most stations ran radio and internet together. A few experienced some interference from one system to the other.

Participation in the JOTI is increasing. The strong points of the JOTA remain, however, unchanged: to be able to communicate from those places that do not have any form of public communication network available. It is fascinating time and again to see a small box make contacts world-wide, without being hooked up to a network.

The Swiss JOTA team will host a national JOTA / JOTI seminar in Interlaken next July.

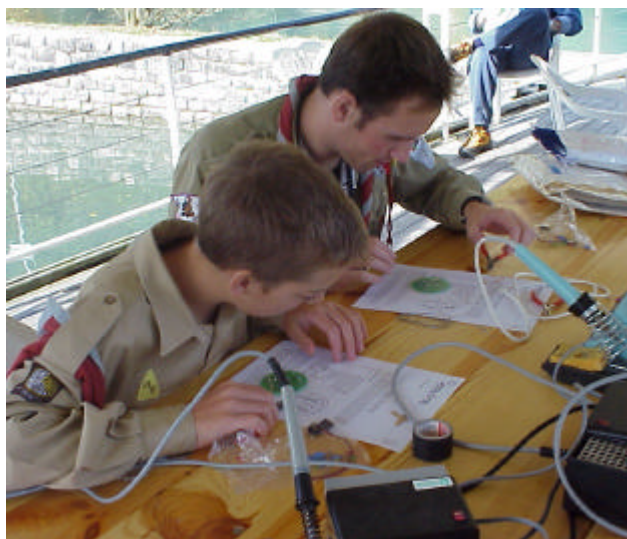

Where does this blue wire go?

### Trinidad and Tobago (9Y)

participants:	120
stations:	1
internet:	1
countries:	4

The main JOTA weekend was held

at the Scout headquarters, which is also the home of the amateur radio society, writes Mervijn O'Neil. The Scouts came from rural areas and held several scout activities while awaiting their turn on the radio or computers.



On the air and on the internet.

Most Scouts came in during the peak morning period. This is not ideally suited for radio communications. I have recommended that late evening and night be used next year, says Mervijn.

### Tunisia (3V8)

participants:	62
stations:	3
internet:	5
countries:	23

Despite the bad weather, winds, cold and rain, more than 60 Scouts of all ages have come to live this unforgettable experience of live contact with other Scouts all over the world and to re-enforce the Scout brotherhood, writes the Tunisian Scout Association. For some Scouts it is their 4<sup>th</sup> JOTA, others are there for the first time.

Transmitting from three stations we had a lot of fun contacting each other, a sort of "intra-JOTA". This helped since not that many speak foreign languages.



"...listen, here's a joke...."



We were impressed with the warm welcome we got from the stations we made contact with. Also warmth, but in a different sense, brought a lightning stroke close to the station.....

The Scout comment that they would like to be involved in a training course to learn more about the possibilities of the JOTA program.

### Turkey (TA)

participants:	451
stations:	9
internet:	5
countries:	9

The main event was the national census we had on Sunday. That has locked everybody in their homes, explains Savas Baran. Some Groups like Istanbul and one in Ankara stayed at their JOTA centre to continue the communication. Ankara, Istanbul, Eskisehir, Kayseri and Antalya provinces were very active. This year a scout and guide group in Ankara organized their JOTA/JOTI station on a hyper market in a shopping center of Bilkent University. This place is one of the crowdest places in the world. This was a big help to get a high number of visitors. Everybody asked a question. Half of them was working on JOTA /JOTI and the other half was giving answers to visitors.



JOTA:48 hour operation....



Now click here, then move your mouse down....

Eskisehir scouts and guides camped within the city on the premises of the Youth and Sports Directorate facilities so they could run home early in the morning before the census deadline.

Istanbul Scout Club organized JOTA at their building and scouts and guides stayed on premises all weekend. They put their pictures to their web page.

Communication was very well nation-wide (no language problem).

We created, during the JOTA, an international symposium on volunteerism for disaster communications. We exchanged views with TRAC members. Some people begin to think that cellular phones are the solution. The Marmara earthquake proved them wrong. Luckily there were mobile radio amateurs around. Some Scouts assisted them as operators or helpers.

It is very difficult to get reports from the leaders on JOTA, concludes Savas, "it is just like to get the meat out of between the teeth of the lion with bare hands."

### United Kingdom (G)

participants:	3500
stations:	96
internet:	0
countries:	40

Richard Gaskell, just been appointed as UK JOTA Organizer, sent us the following enthusiastic stories: Although fewer stations applied for special call signs and there were fewer visitors overall those who did join in the 43rd JOTA weekend had a great time. This year we tried asking stations to send in two slightly different reports, one from the radio amateur responsible for the station and one from the Scout leader. The radio amateur who didn't know a Beaver from a Baloo and the Scout who couldn't tell a band plan from a balun could send information about the two sides of the event which could be combined to give a clearer picture of the whole. The percentage of reports returned is encouraging and all are included. We owe them all our thanks.

Almost all stations, even some of those restricted to VHF operation, managed contacts with JOTA stations outside the UK. Many stations comment on the positive views of Scouting apparent in many non-JOTA contacts and how many have links to the movement, past or present. Many stations renew old contacts. GB4YOU managed three of four Icelandic stations chatting to the operators from the 1999 National Jamboree. Others forge new links. GB2EDS were particularly pleased to contact 9H1SVS, a Maltese Scout group, as they had Scouts originally from Malta in the shack. Scouts on the Island of Jersey were joined by Scouts from the mainland and GB0MKS in Milton



My name is Gumus....

Keynes had their best contact with Mark in Indiana who didn't know about JOTA but woke his three Scout sons, put them on the radio then sent them off to collect the rest of the troop. Several stations had contacts with MX0WSM, the speed boat museum at Windermere while GBOGDS had contact with RV6LMG/AM, an aircraft over Siberia.

Generally good weather across the UK and excellent radio conditions made life easier for those setting up stations in unusual circumstances. GX4PSG were so impressed with their G4HOL aerial, they sent full instructions with their report. It might be kind to pass on this information to GB4CDS who wondered if their aerial was effective as they thought the bands quieter than usual.

JOTA is often combined with other activities including camping and pioneering, DF hunts and radio fox-hunting, challenges and awards but for the young Cub or Scout the highlight is talking to another Scout in another troop far away. We are lucky that our Scouts and Guides are allowed to talk to Scout and Guide stations during JOTA.

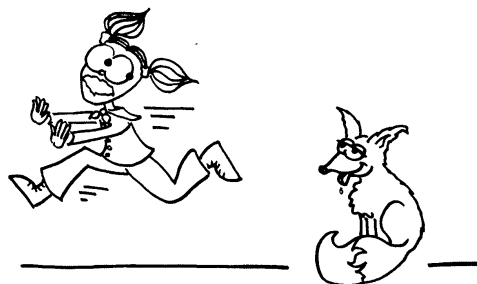

Fox hunt.....

### United States (W, K, N)

participants:	13871
stations:	1911
internet:	0
countries:	51

Ray Moyer says: the operations in the USA involved one or two Scouts and amateurs to over 1100 scouts and 30+ amateurs. Scouts mentioned as the most interesting contacts of the weekend: talking to Geneva Headquarters, tracking the shuttle, contact with a Salvation Army emergency group and discussed differences between them and the Red Cross, talked about trading cards and set-up a trade, listening to foreign languages, traded stories about life in Guam and West Texas, learned about fishing in Australia, exchanged information on scout uniforms and ranks with scouts in Germany, France and England, operated from a WWII Sub, worked Gilwell Park and K2BSA in Texas, worked an American that was on the Amazon River on a Riverboat.

Funny situations that we noted: a Scout spoke Japanese to a young lady he thought was from Japan but the girl lived in Puerto Rico and did not have a clue what he was saying; a French Scout calls a Scout Nickels instead of Nicholas; several Scouts wanted to talk to girl Scouts but when a group of girls were contacted the boys became mike shy; Ben from Troop 39 was talking to another scout just like old pros but both scouts were new to amateur radio. With proper training they will be great; trying to say foreign names; voices sounded like they were out of Star Wars Movie.

JOTA Activities and Ideas that were liked best: building antennas; trading SSTV pictures with other scouts; ATV - Boys rushed over to the camera so they could be on TV; hooked up an oscilloscope to a mike to see their voices; Morse sending and receiving to earn a certificate; PSK-31 was a big hit; digital camera to take pictures of scouts to put on a card for them; demonstrated open and closed circuits; make posters to promote JOTA and put them in schools.

### World Scout Bureau (HB9S)

participants:	85
stations:	1
internet:	1
countries:	66

The World Scout Bureau's amateur radio station joined in the 43<sup>rd</sup> JOTA from the Scout centre "les Pérouses", just outside the centre of Geneva. Here we had plenty of space to erect antennas.

Since it was the first JOTA in the new millennium, we got permission to use the figure 2 in the call sign prefix, instead of the usual 9.

Eric, HB9IAB provided us with a ladder truck. We have never used something like this before, but soon discovered how convenient this is to raise a 3-element HF beam antenna to 30 m height. Other masts carried the dipole antennas for the 40 and 80 m bands. To complete the set up, we installed VHF antennas (almost at ground level) to connect us to the digipeaters on top of the Jura Mountains. These gave us access to the packet-radio network and the DX clusters. Another first was the Slow-Scan-TV station we ran on 20 m. And we could operate all this together with little or no interference.



The crew of HB2S.



Frank M0AEU, Lisbeth OZ1JRD, Mike LX1KQ, Philippe LX2AJ, Yves HB9AOF and Richard PA3BAR formed the operator crew. Almost all of them served also on the XR3J team at the World Jamboree in Chile. So this was a small reunion too.

HB2S enjoyed the perfect conditions that the radio bands offered to the JOTA. We made 426 contacts in 66 different countries. The QSL manager ran out of cards and had to print extras.

More contacts than ever were made with distant Scout stations. We tended to give priority to these stations, as the European ones would be able to contact us anyway during less favourable radio conditions.

Gilwell Park GB2GP, HB9JAM in Bern, A47JOTA in Oman, CE3JAM in Santiago Chile, Scouts at the Council of Europe in Strassbourg TP2000CE, TF5JAM in Iceland, 9K2BI in Kuwait City, Scouts in Azerbedjan 4K1AS and White River Scouts in South-Africa, ZS6WRS were amongst the many JOTA stations we managed to speak to over the weekend.

Frank had a lot of fun with the Slow-ScanTV pictures we exchanged with many stations worldwide. How to cope with a pile-up in SSTV? He needed to process the digital photo's he took at the station, add some text and put them on the air at an amazing speed.

Yves entered into a contact with Lin, BV4VE only to be surprised that the operator knew so much about him. He soon discovered he had met him as a Scout interested in radio in Shinshu (Taiwan) some 5 years earlier. Lin now has his own amateur radio license and took part in he JOTA!

Another first for HB2S was the presence of a YL operator in our crew. Lisbeth operated several of the stations and surprised many a Scout.

Whilst the large beam antenna was running on 10 m, Richard retuned the 40 m dipole to try to work on 15 m. Only to discover that he could contact E20AJ at the World Jamboree Office in Bangkok with loud and clear signals on just this piece of wire as an antenna. Radio is full of surprises.

A remarkable contact we made with a polish expedition group in Antarctica. This group picked a very cold spot to operate for the JOTA weekend with HF0POL.....

And what do you do if you are an operator and your own kids just joined a Scout group taking part in JOTA? Well, you make a sked for a contact. The local troop leader in Nijkerk didn't believe that such a thing could work, since they never before had succeeded to contact HB9S. But of course it did. To Stephanie and Christian it was the most natural thing to speak to "my dad in Geneva".....

We spoke to GB2DHH where the Scouts operated from an Air Museum in St. Albans, north of London. The original Comet airliner was the most popular one of all planes on display.

That radio conditions were favourable, proved JH8BHR, a Scout from Japan who contacted us with a self-built small transmitter of just 3 Watt.

Some 30 Scouts in a cabin, it's a bit cramped, so the eagle patrol must sleep outside, without a tent. No problem, unless it's a freezing 0 °C as was the case in the north of Finland at OH6FA.

Via the digital radio network we contacted YO5PEB, a Scout group founded in Romania by Dutch radio-scout John Visser.

A beautiful signal came to Geneva on the early Sunday morning from V5TSB in Tsumeb, Namibia. "You made our day", scout master Jim Kastelic said, "we can now put the special grey pin we saved for you on our map". Jim had been trying all weekend to contact the World Scout Bureau station. His Scout group is quite undertaking; they just sent some of their Scouts to Mongolia for a community project.



Lisbeth's talk show on 10 meters.....



SSTV: and in the end you get your own pictures back !

# 7. Kit corner

We present you the seventh edition of our electronic kit building corner. The intention of this chapter is to provide you with some ideas and suggestions. Many simple circuits that are suitable to build with your scouts can also be found on our web site: [www.middelkoop7.myweb.nl/Games](http://www.middelkoop7.myweb.nl/Games).

The following is suggested by the Danish JOTA committee and presented in the Danish JOTA report 2000:

## **Mine sweeping as a Scouting activity?**

*Together with Handicap International, WOSM developed in 1998 activity materials and an inspiration video with the title "Together, we can make a mine free Earth!". The initiative was taken after the 1997 Nobel Prize went to the international campaign forbidding land mines. The campaign started in 1992 and is today supported by more than 1300 organisations in over 70 countries. Land mines are cheap weapons, but they most often kill and wound civilians, including many children, that, while going for water or looking after the animals, come across a land mine. The mine can be placed there years earlier, but cleaning up the mined areas after the conflicts has ended, costs far more than the local population can afford.*

*As a movement whose purpose is to contribute to the development of responsible, independent, young people both locally, nationally and internationally, it is natural for the scout movement to contribute to the knowledge on threats against children and youth health. The developed education and activity material focuses on the problem of remaining land mines, and by different scouting activities, it introduces the scouts to the conditions, the wounded victims often live under.*

*The activities are explained in the folder "Mines! An awareness game on the problem on anti-personnel mines". The folder can be ordered from the World Scout Bureau in Geneva.*

*This years JOTA/JOTI-project is a "land mine", which can be used to simulate a mine sweeping exercise. Even though the scouts should not be trained to remove land mines, the activity should be used to create attention and increase the scout's knowledge on land mine problems.*

*The "mine" is armed and placed in an area, perhaps even hidden. Now the scouts have to find the mine and bring it to a "safe" area, without detonating the mine. The detonation switch is made from a mercury switch, a balanced spring or other types of motion-sensitive switches. The detonation can be simulated by an LED, a buzzer or a power resistor taped on a balloon, which will crack by detonation.*

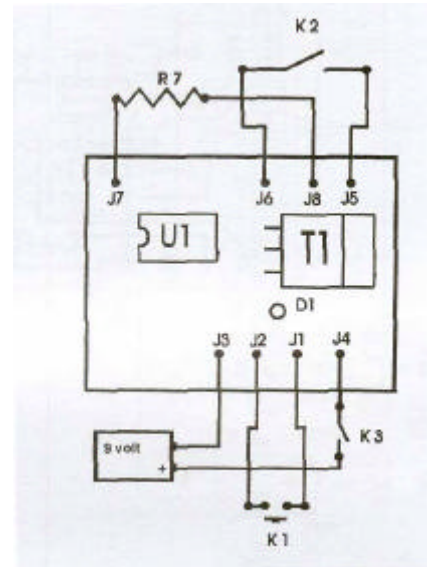

### Component list:

C1	10 uF / 16 V electrolytic
C2, C3	47 nF
D1	led
D2	1N4148
J1 - J8	contact points
K1	mercury switch or similar
K2	switch
K3	switch
R1, R2, R3	100 k $\Omega$
R4	180 k $\Omega$
R5	820 $\Omega$
R6	1500 $\Omega$
R7	10 $\Omega$
T1	BD 233
U1	LM 555

9V battery, battery clip, some wire, a casing (plastic box or similar).



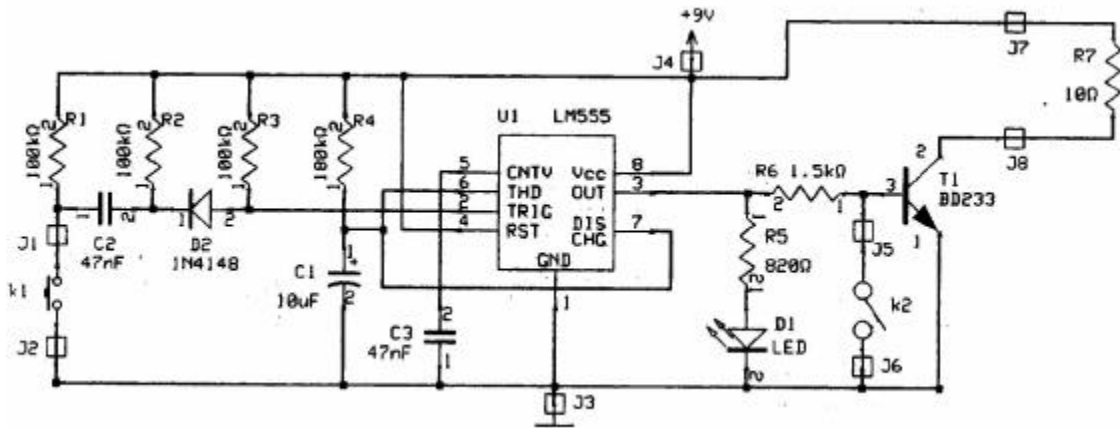

Circuit diagram.

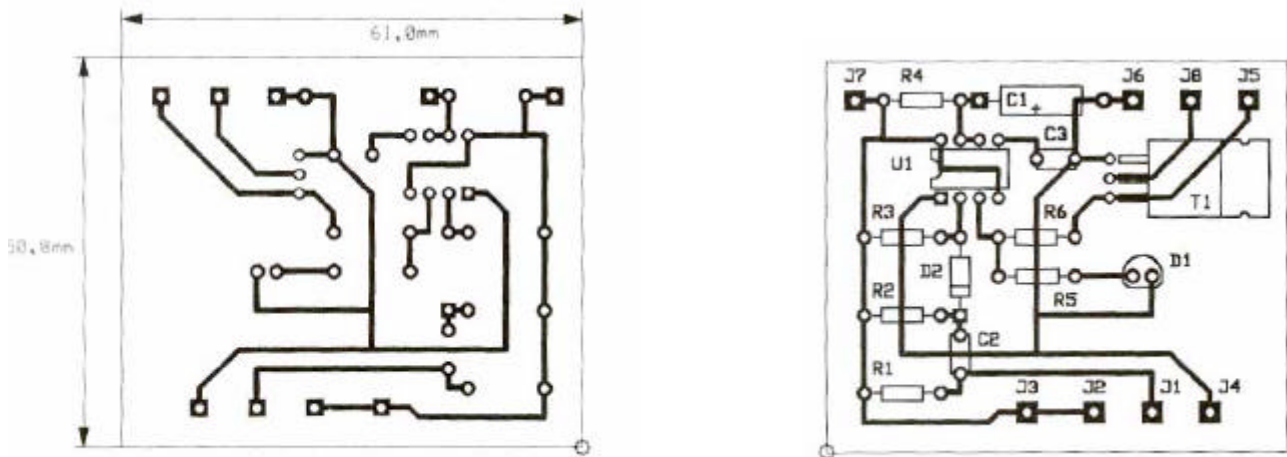

Double-sided printed circuit board

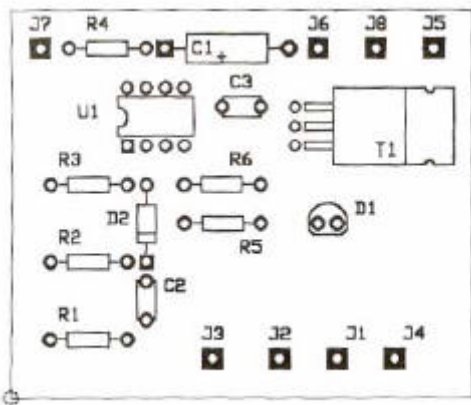

Solder resistors R1 - R6 (NOT R7 ! ) to the circuit board. Solder diodes D1 - D2 and capacitor C1 - C3 to the circuit board. Solder T1 and U1 to the board. Finally, solder K1 - K3 to the board, with some extra wire, so the switches can be mounted in the casing. Also solder the battery clip to the board.

After the components are mounted on the circuit board, the battery and the switches are mounted in a casing. K1 is a mercury switch or a similar motion-sensitive switch. This is fastened solid to the casing. Any sudden movement of the casing could cause the "mine" to "detonate".

K1 is connected to terminals J1 - J2. R7 is the resistor, which will be fastened to a balloon with tape. It is important, that the tape does not cover the resistor, but is fastened to the wires of the

resistor. These wires are then connected to the circuit board on connectors J7 - J8. When the mine activates, the resistor will warm up, causing the balloon to explode. Be sure, that the resistor is in close contact with the balloon. K2 is closed when you want to use the mine without blowing up the balloon. When it is closed the detonation of the mine will be shown only by D1 going ON. D1 will light every time the mine detonates. K2 is connected to terminals J5 - J6. When the mine is placed or hidden in the area, use K2 to place it safely without any detonation. After the mine is placed, opening K2 arms it. K3 is used to turning the power ON and OFF. K3 and the battery clip are connected in series to terminals J3 - J4.

# 8. Forthcoming radio-scouting events

During the summer there will again be a number of large (inter) national camps and activities that have a scout amateur radio station on the air. To easily find these stations, scout stations in the European Region are asked to call CQ SCOUT daily during July and August for the universal "summer camp sked":

European Summer Camp sked:  
on 7.090 MHz at 07.00 GMT and  
on 14.290 MHz at 07.30 GMT

At the time of print, the following activities were known:

- June 04 - 07           OZ1RDP radio weekend Bremer "Funkergilde", RØMØ-Island.
  - June 30 - July 07     LA1SS National Jamboree, Frerikstad, Norway. 11000 participants.
  - July 23 - August 01   K2BSA 15th National Jamboree, Fort A.P. Hill, Fredericksburg VA, USA, 38000 part.
- For additional last-minute info see [www.middelkoop7.myweb.nl/News](http://www.middelkoop7.myweb.nl/News)

## SCOUT NETS.

Weekly or monthly nets exist in which licensed Scouts meet on the air:

Country	day	time	frequency	netcontrol
Denmark	Saturday	13.00 GMT	3.740 MHz	
European Scout Net	Saturday	09.30 GMT	14.290 MHz	PA3BAR
Germany	1st Sunday of month	16.00 GMT	3.678 MHz	DF0VCP
	3rd Wednesday of month	20.00 local	packet-convers	DB0EAM
Japan	3rd Saturday of month	23.00 local	21.360 MHz	JA1YSS
United Kingdom	Saturday	09.00 local	3.740 MHz	G4PSG
Netherlands	Saturday	19.00 local	3.740 MHz	PI4RIS
Norway	Saturday	15.30 local	3.740 MHz	
Sweden	Saturday, even weeks	15.00 local	3.740 MHz	
United States	Sunday	20.30 GMT	14.290 MHz	K2BSA

Since many years, scout stations have used the frequencies below to easily find each other on the bands.

## World Scout Frequencies:

band	phone (MHz)	cw (MHz)
80 m	3.740 & 3.940	3.590
40 m	7.090	7.030
20 m	14.290	14.070
17 m	18.140	18.080
15 m	21.360	21.140
12 m	24.960	24.910
10 m	28.390	28.190

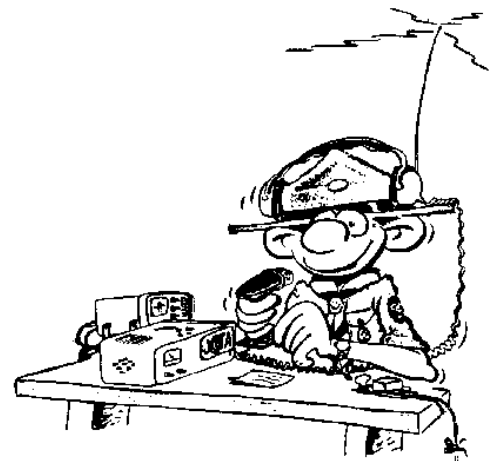

# 9. The 44<sup>th</sup> JOTA

44<sup>th</sup> Jamboree-On-The-Air, 20 - 21 October 2001.

The logo for the 44<sup>th</sup> JOTA, is shown on this page. It is a design following an idea of 15-year old Juliane Schröder of the DPSG group St. Remigius in Borken, Germany.

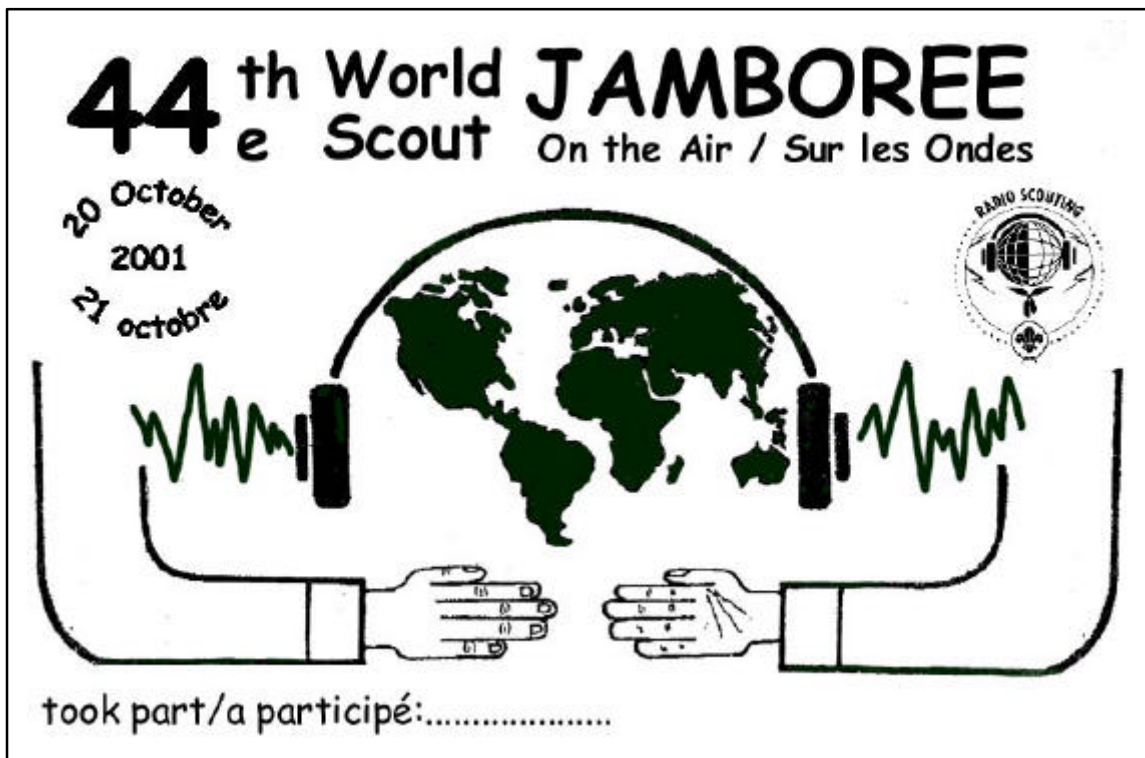

## **Look for this information:**

The following information will be mailed on paper to all Scout Associations as well as emailed directly to those National JOTA Organizers listed in chapter 10.

### **June 2001:**

the first JOTA circular, with proposed theme activities and programme suggestions for the 44<sup>th</sup> JOTA that you may use in preparing your national JOTA programme.

### **August 2001:**

the second JOTA circular with the latest JOTA news, the operating frequencies and a report form for national use. With this mailing the participation cards will also be send.

### **November 2001:**

the third JOTA circular with a reminder to send your reports on time to Geneva and some last minute information on Radio-Scouting activities.

### **March 2002:**

the World JOTA Report (WSB ref.nr 1310) will be there again. Extra copies can always be ordered directly from the World Scout Bureau, on-line at the web site of SCORE, the world scout shop: [www.worldscoutshop.org](http://www.worldscoutshop.org). Look in the radio-scouting section.

You may also check the WOSM web site for JOTA information at regular times: <http://www.scout.org/jota>.

In addition, the circulars are also uploaded to the "scouts@WW" and "jota@WW" sections of packet-radio bulletin boards at regular times. Check your own packet-radio mailbox server station. Now is the moment to start your preparations !!



# 10. National JOTA Organizers

=====

**World JOTA organizer** : Mr. Richard Middelkoop, Cornelis van Ramshorstlaan 13, NL-3863 AZ Nijkerk, The Netherlands;  
packet: PA3BAR@PI8UTR email: rmiddelkoop@world.scout.org.

**HB9S station manager and JOTA advisor** : Mr. Yves Margot, 7 Rte.A. Ferrand, CH-1233 Lully, Switzerland;  
packet: HB9AOF@HB9IAP email: hb9aof@uska.ch.

=====

*This list contains the names of the active National JOTA Organizers (NJO), i.e. those who have sent reports to the World Scout Bureau at least once during the past two years. Packet-radio- and email addresses have been added where known to us. Information on JOTA is sent directly to the NJO's below and is also sent to the International Commissioner of every Scout Association as well as to the World and Regional Scout Committees.*

**Australia** : Mr. Stephen Watson, VK4SGW, 7 Landel Court, Kirwan, QLD 4817.  
Email: shwatson@bigpond.com.au.

**Austria** : Mr. Walter Nowakowski, OE1WN, Breitegasse 13, A-1070 Wien. Email: BBPAF@ppoe.at.

**Bangladesh** : Mr. Aminul Kawser, S21D, 70/1 Purana Paltan Line, Inner Circular Road, Kakrail, Dhaka 1001.  
Email: esc@agni.com.

**Bolivia** : Mr. Camilo Zeballos Gutierrez, Casilla postal 3093, Cochabamba.  
Email: scoutasb@comteco.entelnet.bo.

**Canada** : (SC) Ms. Lena W. Wong, Scouts Canada, 1345 Baseline Road, Ottawa, Ontario K2C 0A7.  
Email: lwong@scouts.ca.  
(ASC) Mr. Jean-Yves Ruault, VE2JAM, 7679 avenue Papineau, Montreal, Quebec, H2E 2H1.  
Email: jslo@asc.ca.

**Chile** : Mrs. Isabel Carreño Arellano, CE3TLE, Av. Ejercito 177, Casilla 21113, Santiago 21.  
Email: CE3TLE@hotmail.com.

**China Republic** : Mr. Tim Kuo, 13F, 20 Chu-Lun Street, Taipei 104. Email: timk@scout.org.tw.

**Croatia** : Mr. Vladimir Jurkic, 9A1ACD, Pino Budicin 31, HR-52100 Pula. Email: tjurkic@hotmail.com.

**Cyprus** : Mr. Errikos Lanitis, 5B4GJ, P.O.Box 40216, Larnaca 6302.

**Czech Rep.** : Mr. Hana Konvicka, OK1TMP@OK0PPR, Malenicka 1791, CZ-14800 Praha 4.  
Email: knihovna@htf.cuni.cz.

**Denmark** : Mr. Brian Lodahl, OZ2BRN, Sonjavej 42, 1A, DK-9000 Aalborg. Email: brianlodahl@kfumscout.dk.

**Dominica** : Mr. Joseph Russell Raymond, J73RJ, P.O. Box 677, Roseau.

**Finland** : Mr. Markus Hamro Drotz, OH2KMT, Siirinkuja 2, FIN-02700 Grankulla. Email: oh2kmt@sral.fi.

**France** : Mr. Luigi Malandrino, F6ICJ@F1DRW, Chemin du clos devant, F-71960 Prissé.  
Email: lmalandr@scouts-france.fr.

**Germany** : (DPSG) Mr. Klaus D. Sperling, DC4NA@DB0BOX, Leharstrasse 8b, D-90453 Nürnberg 60.  
(VCP) Mr. Günter Erdmann, DL9BCP@DB0VER, Wecholderstrasse 59, D-28277 Bremen.  
Email: gerdmann@gmx.de.  
(BdP) Mr Lars Weimar, DG4SEV@DB0ULM-8, P.O-Box 1116, D-89130 Blaustein.  
Email: meikapu@weisse-rotte.de

**Honduras** : Mr. Raul H. Delcid Castro, HR1RHD, Col Ruben Dario Frente Gimnasio Cibex,  
258 Tegicigalpa M.D.C.. Email: scouts@ficensa.com.

**Hong Kong** : Scout Amateur Radio Club, 10/F Hong Kong Scout Centre, 8 Austin Road, Kowloon.

**Hungary** : Mr. Tibor Véghe, HA5YI@HA5OB, Kerepesi-u 30 I 21, H-1148 Budapest.  
Email: ha5yi@gw.ha5kfu.ampr.org

**Iceland** : Mr. Konrad Thorisson, TF3KET@TF3NOS, Gardaflot 7, 210 Gardabaer. Email: konth@skima.is.

**India** : Mr. S.Kumar, VU2BSG, P.O. Box 7043, New Delhi 110002.

**Indonesia** : Mr. H. A. Rivai Harahap, Jl. Medan Merdeka Timur No. 6, Jakarta 10110.  
Email : kwarnas@jakarta.wasantara.net.id

**Ireland** : Pat Geoghegan, EI9EZ@EI2HH, 24 Shanbally, Cappoquin, Co Waterford. Email: geoghegan@iol.ie

**Japan** : Mr. Toichiro Nishiyama, JA1OBY, No.11-10, 4-chome, Osawa, Mitaka-shi, Tokyo 181-0015.  
Email: bsn@scout.or.jp.

- Kuwait** : Mr. Mohamed H. Al-Humaidi, P.O. Box 5172 Safat, 13052 Kuwait.  
Email: scout@mail.qualitynet.net.
- Madagascar** : Mr. Ranarisaona Raymond, P.O. Box 4402 Salfa Tananarive, 101 Antananarivo.  
Email: appio@salfa.org
- Malaysia** : Mr. Wang Nyap Tang, 6 Lorong Bunga Kekwa, Taman Bunga Kekwa, 14000 Bukit Mertajam, Penang. Email: wntang@tm.net.my.
- Mexico** : Mr. Xochitl Prado Serrano, 4C1ASM, Cerro Compostela #10, Col. Campestre Churubusco, C.P. 04200 México D.F. E-mail: xochitlprase@usa.net.
- Morocco** : Mr. Adil Freidji, 57 bloc 3 youssoufia est, Rabat 10000.
- Mozambique** : Mr. Silvio José Monteiro, Rua Costa Serrao 231 e/c, Beira. Email: ferreira.lda@telepata.mz
- Namibia** : Mr. Jim Kastelic, P.O. Box 228, Tsumeb. Email: kastelic70@yahoo.com.
- Neth. Antilles** : Mr. Hubert Martha, PJ2SA, Kaya Araña 93, Romar Estate, Curaçao.  
Email: Hubertmartha@hotmail.com.
- Netherlands** : Mr. Jan Kluiver, PB0AMJ, Lallamanstraat 18, NL-2841 CD Moordrecht.  
Email: PB0AMJ@Amsat.org.
- New Zealand** : Mr. Jim Parnell, ZL2APE, 87 Duncan Terrace, Kilbirnie, Wellington 6003. Email: jim-p@ihug.co.nz.
- Norway** : Mr. Dag Anders Kjærnes, Ravnaasveien 87, N-1254 Oslo. Email: dagak@online.no.
- Oman** : Mr. Dawood Nadhar Al-Zadjali, A41JX, National Organisation for Scouts and Guides, P.O.Box 1528, PC 112 Ruwi. Email: omnscout@gto.net.om.
- Panama** : Mr. Eric A. Macias, HP1EAM, Bethania Calle 67 final, 6-8783 El Dorado Panama.
- Peru** : Mr. Luis Hinojosa Pacheco, Av. Arequipa 5140 Miraflores, Lima 18. Email: jotayjoti@latinmail.com.
- Poland** : Mr. Jan Ladno, SP5XM, ul. Nowolipki 10 m 80, PL-00-153 Warszawa.
- Portugal** : (CNE) Mr. José Augusto Marques Joaquim, CT1EHZ, Rua Dom Tristao Vaz Teixeira no. 5 - 2º, Frente, P-2675-601 Odivelas.  
(AEP) Mr. Manuel Celestino dos Santos Martins, CT1ASU, Av. Combatentes de Grande Guerra, Bl.5 3e esq. P-8700-440 Olhão. Email: ct1asu@hotmail.com..
- Romania** : Mr. Nicolae Draguleanu, YO3CZ, Aleca Porana Mare 6, bloc B 8/47, seet 6, 77308 Bucuresti.  
Email: draguleanu@pcnet.ro.
- Senegal** : Mr. Mamadou Daffe, 6W1IRQ, 5 Rue Pierre Millon, BP744, Dakar. Email: cod@telecomplus.sn.
- Slovakia** : Mr. Josef Bojanovsky, OM3OF, Kosikarska 14 / 1431, 915 01 Nove Mesto nad Vahom.
- Slovenia** : Mr. Primoz Bajec, S57RUT, Pivska 1, SI-6230 Postojna. Email: bajecp@hotmail.com.
- Spain** : Scouts de Aragón ASDE, Fernando de Antequera 2, E-50006 Zaragoza.  
Grupo Scout Severo Montalvo ASDE, P.O. Box 148, E-30880 Aguilas. Email: ciadj@ceta.es.
- South-Africa** : Mr. Dave Gemmell, ZS6AAW, P.O. Box 77, Irene 0062. Email: Ber@Mweb.co.za.
- Sri Lanka** : Mr. V. Gunaratnam, 4S7RS, 65/9 Sir C. A. Gardiner Mawatha, Colombo 2.  
Email: slscouts@sltnet.lk.
- Sudan** : Mr. Magdi Osman Ahmed, ST2BSS, Airport-P.O.Box 2, 11112 Khartoum.  
Email: ST2BSS@yaboo.com .
- Sweden** : Mr. Jan Eliasson, SM7NDX@SM7FEJ, Klevavagen 3 C, SE-56027 Tenhult. Email: sm7ndx@mail.scout.se.
- Switzerland** : Mr. Jürg Herbeisen, HB9JAM, Postfach, CH-3000 Bern 7.  
Email: jota@pbs.ch.
- Tanzania** : Mr. Osmund Y. Kipengere, P. O. Box 945, Dar Es Salaam.
- Thailand** : Ms. Sasithara Pichaichannarong, E20BHV@HS0AC, National stadium, Rama Road, Bangkok 10250. Email: sitra@mozart.inet.co.th.
- Trinidad** : Mr. Mervijn O'Neil, 9Y4TT, 7 Grasshopper Lane, River estate, Diego Martin.  
Email: ttscouts@hotmail.com.
- Turkey** : Mr. U. Savas Baran, Define S 2/11, TU-06490 A. Ayranci Ankara.  
Email: bsavas@marketweb.net.tr.
- United Kingdom** : Mr. Richard Gaskell, G0REL, 18 Woodcroft, Kennington, Oxford OX1 5NH.  
Email: G0REL@care4free.net
- United States** : Mr. Ray Moyer, WD8JKV, P.O. Box 152079, Irving, Texas 75015-2079. Email: rmoyer@netbsa.org.

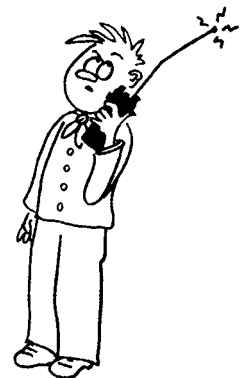



**World Scout Bureau / Bureau Mondial du Scoutisme  
P.O. Box 241, CH-1211 Geneva 4, Switzerland**